

### PROTECTION PRODUCTS

#### Description

RClamp®1561PQ is a low capacitance ESD protection device specifically designed to protect high power RF interfaces. It offers desirable characteristics for board level protection including fast response time, low operating and clamping voltage, and no device degradation.

RClamp1561PQ is bidirectional and features a working voltage of 15V, high ESD withstand voltage (+/-10kV contact per IEC 61000-4-2), and low typical capacitance (0.25pF at  $V_R=15V$ ). RClamp1561PQ has been specifically engineered to minimize harmonic distortion in RF circuits, including high and low GSM bands. This makes it ideal for use on RF, FM, GSM and other antenna circuits commonly found in mobile and automotive applications.

RClamp1561PQ is in a 2-pin SLP1006P2 package measuring 1.0 x 0.6 mm with a nominal height of only 0.50mm. Leads are finished with NiPdAu. This device is qualified to AEC-Q100.

#### Features

- High ESD withstand voltage
  - ♦ IEC 61000-4-2 (ESD) 15kV (air), 10kV (contact)
- Low capacitance: 0.25pF Typical
- Qualified to AEC-Q100, Grade 1
- Protects one high-speed line
- Working voltage:  $\pm 15V$
- Low reverse leakage current
- Solid-state silicon-avalanche technology

#### Mechanical Characteristics

- SLP1006P2 Package
- Pb-Free, Halogen Free, RoHS/WEEE Compliant
- Nominal Dimensions: 1.0 x 0.60 x 0.50 mm
- Lead Finish: NiPdAu
- Marking: Marking Code
- Packaging: Tape and Reel

#### Applications

- RF Antenna
- GPS Antenna
- FM Antenna
- Bluetooth Circuits
- Automated Meter Reading
- Industrial Equipment

#### Nominal Dimensions

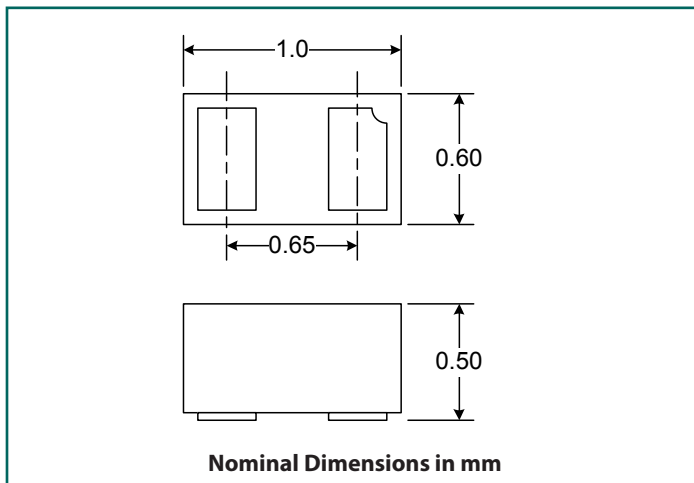

#### Schematic and Pin Configuration

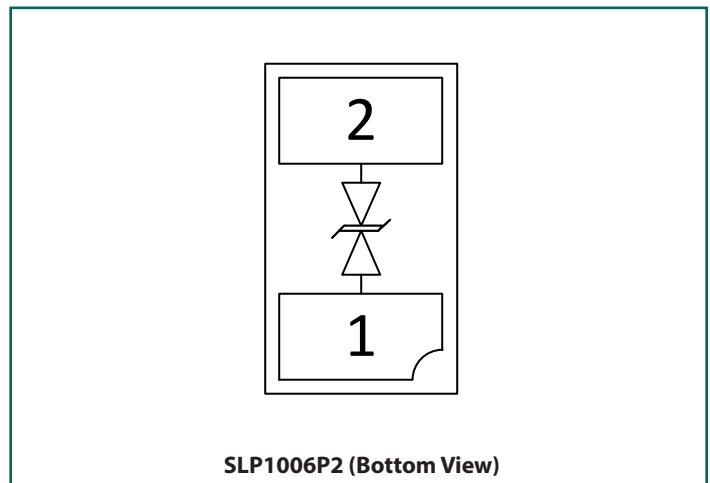

## Absolute Maximum Ratings

Rating	Symbol	Value	Units
Peak Pulse Power ( $t_p = 8/20\mu\text{s}$ )	$P_{PK}$	70	W
Peak Pulse Current ( $t_p = 8/20\mu\text{s}$ )	$I_{PP}$	2	A
ESD per IEC 61000-4-2 (Air) <sup>(1)</sup> ESD per IEC 61000-4-2 (Contact) <sup>(1)</sup>	$V_{ESD}$	$\pm 15$ $\pm 10$	kV
Operating Temperature	$T_J$	-40 to +125	°C
Storage Temperature	$T_{STG}$	-55 to +150	°C

## Electrical Characteristics (T=25°C unless otherwise specified)

Parameter	Symbol	Conditions	Min.	Typ.	Max.	Units
Reverse Stand-Off Voltage	$V_{RWM}$	-40°C to 125°C			15	V
Reverse Breakdown Voltage	$V_{BR}$	$I_t = 1\text{mA}$ -40°C to 125°C	16.5	19	20.5	V
Reverse Leakage Current	$I_R$	$V_{RWM} = 15\text{V}$	T = 25°C	<5	50	nA
			T = 125°C	<5	100	nA
Clamping Voltage	$V_C$	$I_{PP} = 2\text{A}$ , $t_p = 8/20\mu\text{s}$		32	35	V
ESD Clamping Voltage <sup>2</sup>	$V_C$	$I_{PP} = 4\text{A}$ , $t_p = 0.2/100\text{ns}$ (TLP)		29.5		V
ESD Clamping Voltage <sup>2</sup>	$V_C$	$I_{PP} = 16\text{A}$ , $t_p = 0.2/100\text{ns}$ (TLP)		76		V
Dynamic Resistance <sup>2,3</sup>	$R_{DYN}$	$t_p = 0.2/100\text{ns}$ (TLP)		3.8		Ohms
Junction Capacitance	$C_J$	$V_R = 15\text{V}$ , $f = 1\text{MHz}$ T = 25°C		0.25	0.3	pF
Cutoff Frequency	$F_C$	-3dB	>20			GHz

### Notes:

(1): ESD gun return path connected to Ground Reference Plane (GRP)

(2): Transmission Line Pulse Test (TLP) Settings:  $t_p = 100\text{ns}$ ,  $t_r = 0.2\text{ns}$ ,  $I_{TLP}$  and  $V_{TLP}$  averaging window:  $t_1 = 70\text{ns}$  to  $t_2 = 90\text{ns}$

(3): Dynamic resistance calculated from  $I_{TLP} = 4\text{A}$  to  $I_{TLP} = 16\text{A}$

# Typical Characteristics

**ESD Clamping (+8kV Contact per IEC 61000-4-2)**

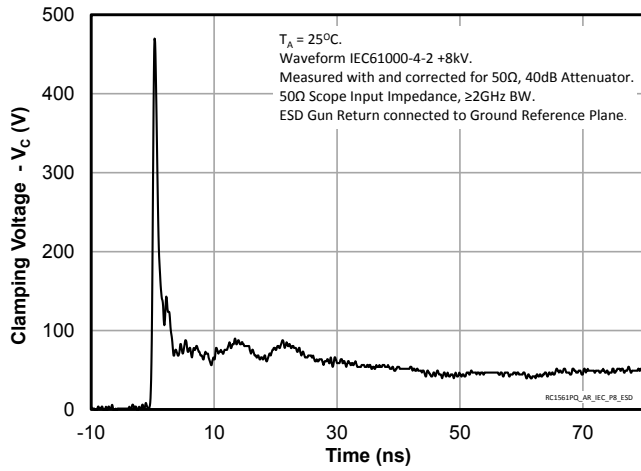

**ESD Clamping (-8kV Contact per IEC 61000-4-2)**

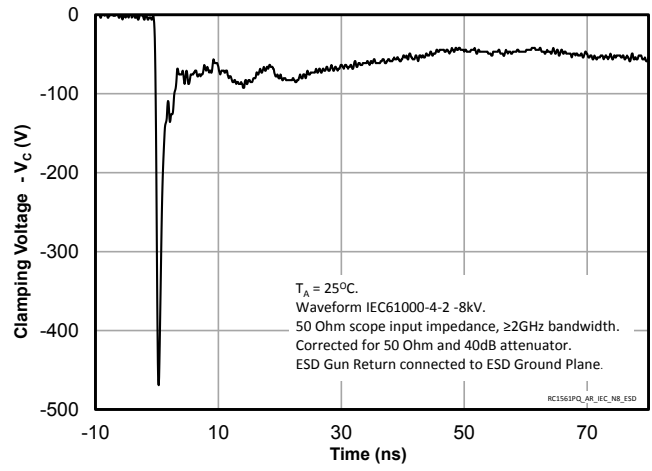

**ESD Clamping (+8kV Contact per ISO-10605 150pF, 330 $\Omega$ )**

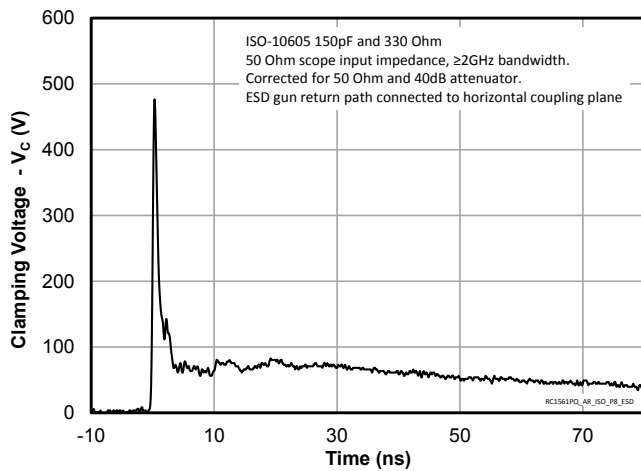

**ESD Clamping (-8kV Contact per ISO-10605 150pF, 330 $\Omega$ )**

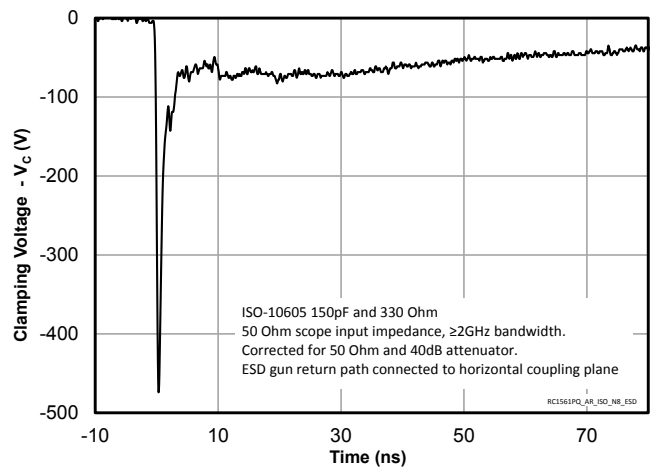

**ESD Clamping (+8kV Contact per ISO-10605 330pF, 330 $\Omega$ )**

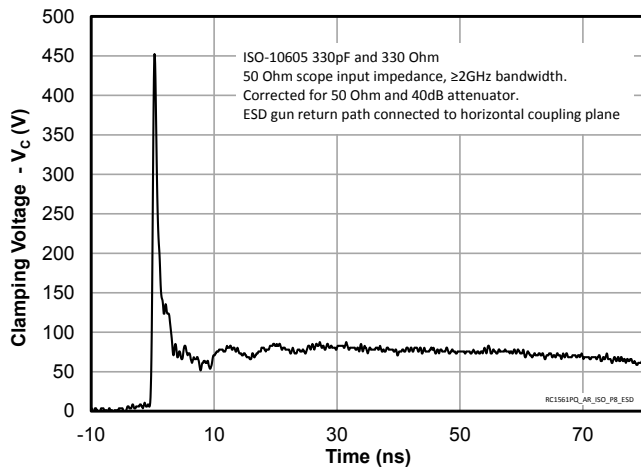

**ESD Clamping (-8kV Contact per ISO-10605 330pF, 330 $\Omega$ )**

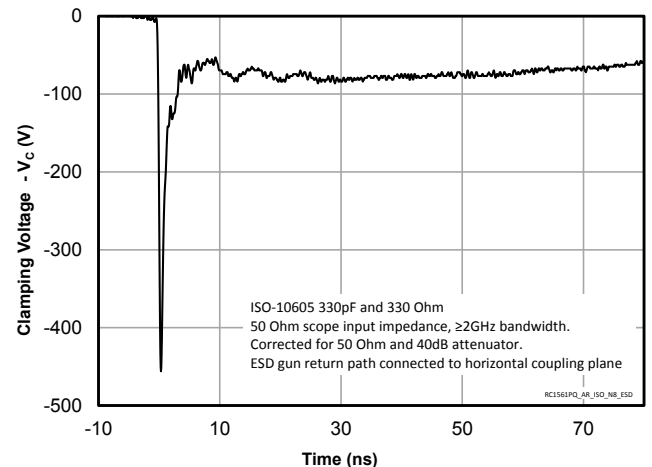

# Typical Characteristics (Continued)

**ESD Clamping (+8kV Contact per ISO-10605 330pF, 2kΩ)**

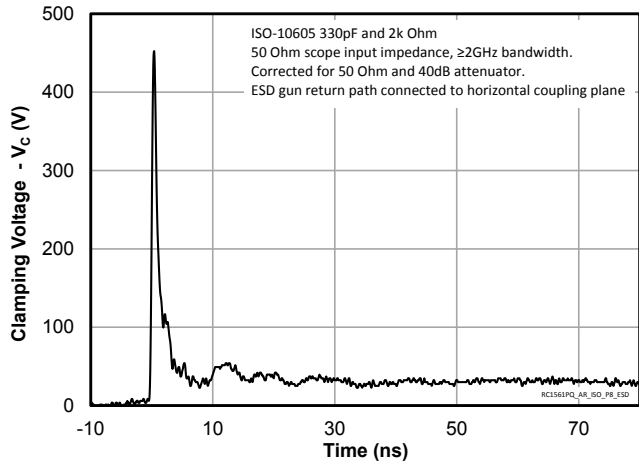

**ESD Clamping (-8kV Contact per ISO-10605 330pF, 2kΩ)**

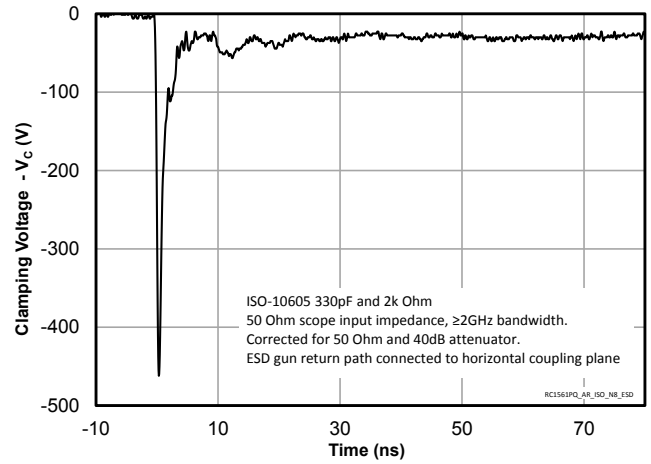

**TLP Characteristic (Positive Pulse)**

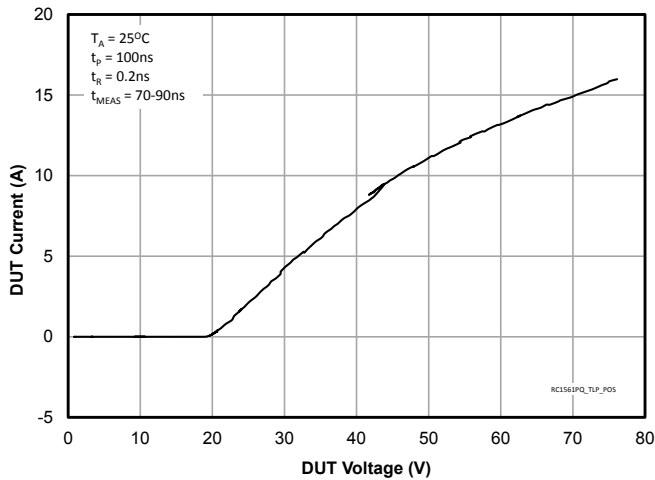

**TLP Characteristic (Negative Pulse)**

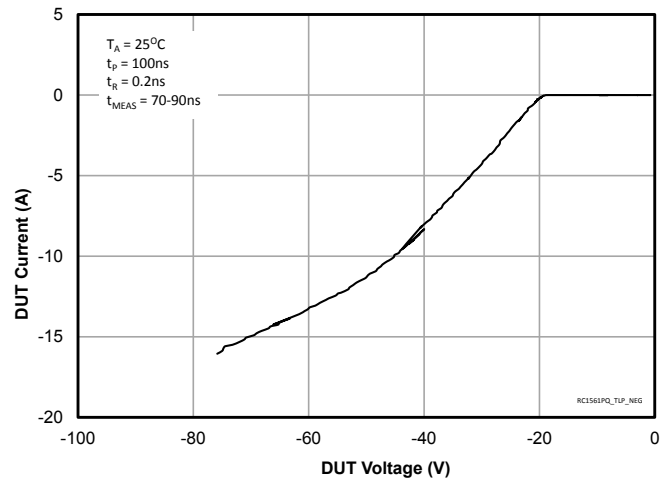

**Capacitance vs. Reverse Voltage**

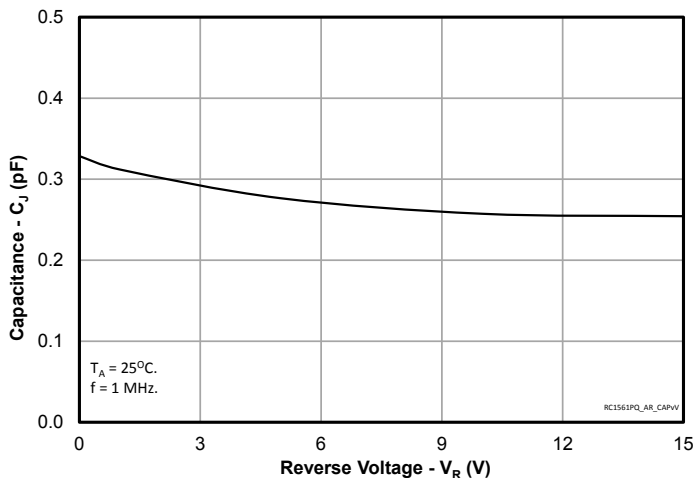

**Insertion Loss (S21)**

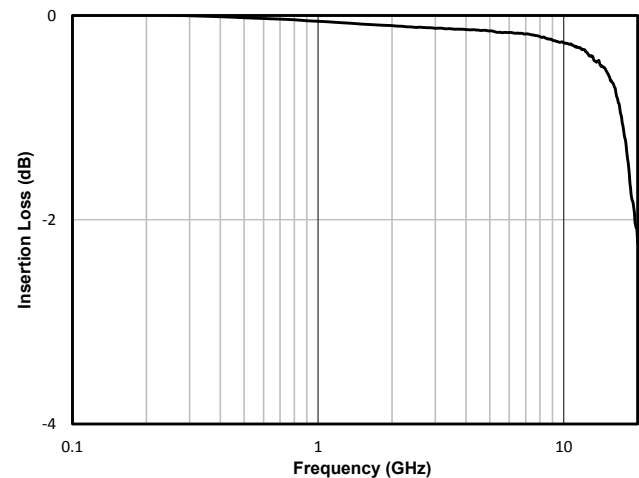

# Typical Characteristics (Continued)

**Breakdown Voltage vs. Temperature**

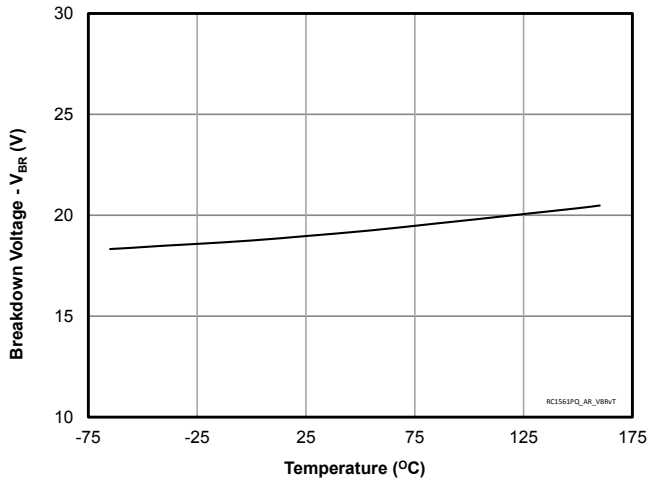

**Capacitance vs. Temperature**

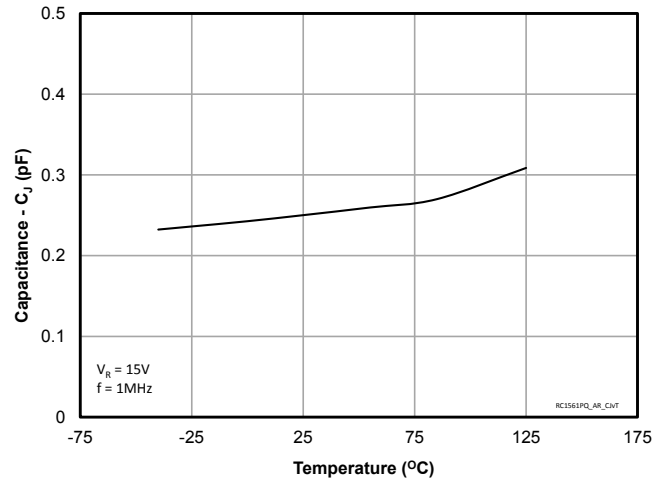

**Leakage Current vs. Temperature**

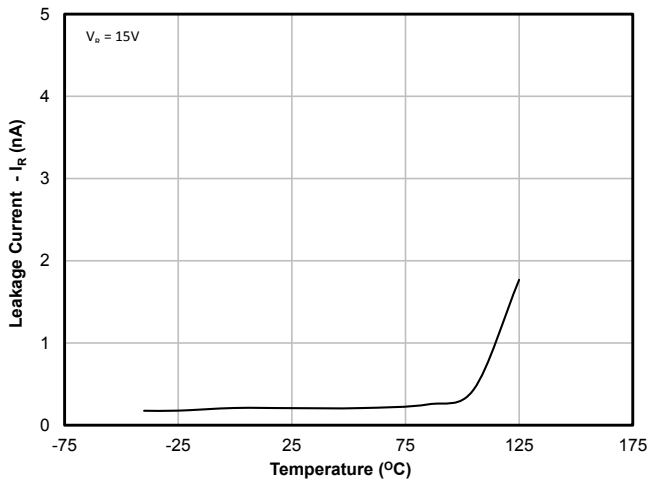

**Harmonic Generation - GSM Low Band**

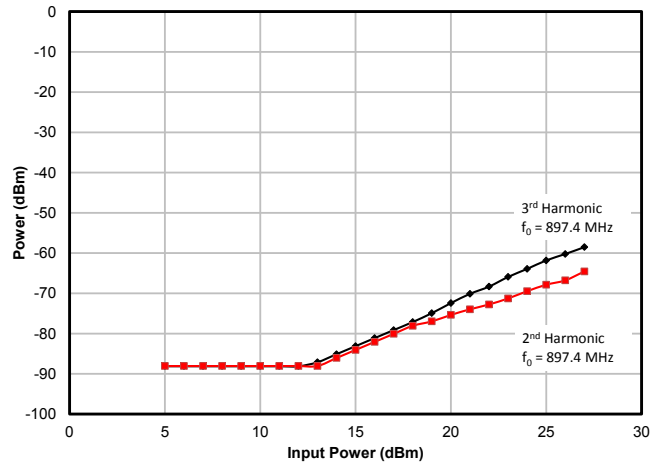

**Harmonic Generation - GSM High Band**

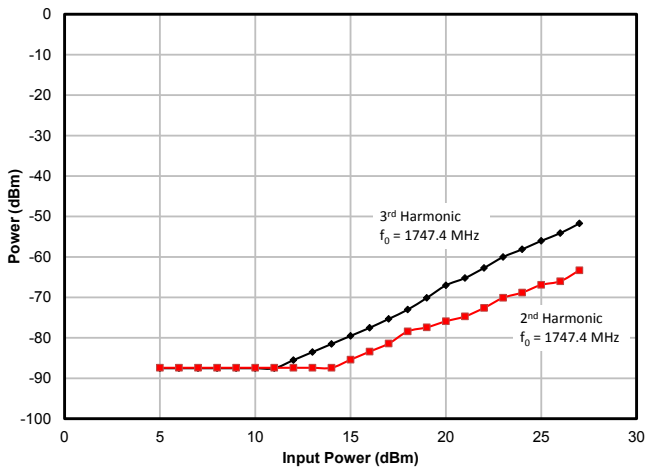

**Intermodulation Distortion (Input: 760MHz + 815 MHz)**

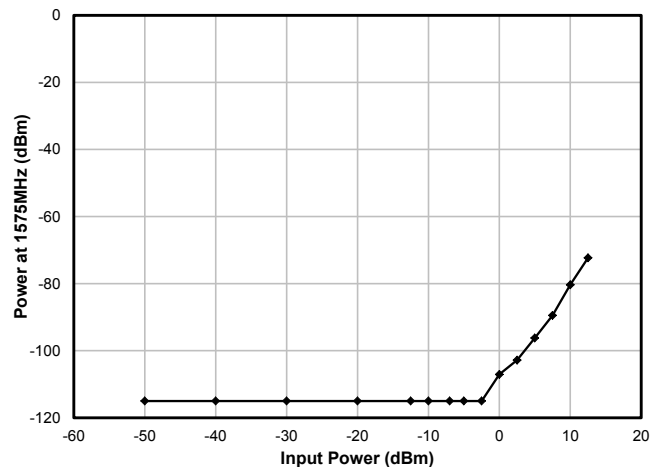

## Outline Drawing - SLP1006P2

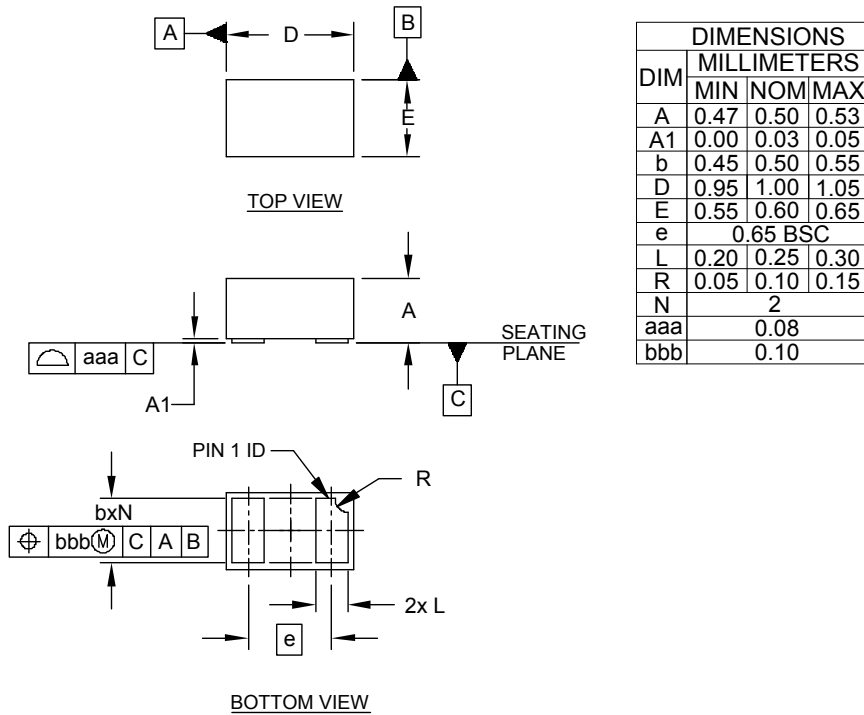

### NOTES:

1. CONTROLLING DIMENSIONS ARE IN MILLIMETERS (ANGLES IN DEGREES).

## Land Pattern - SLP1006P2

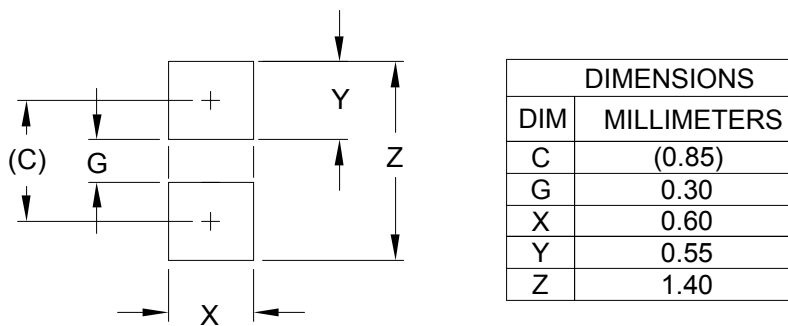

### NOTES:

1. CONTROLLING DIMENSIONS ARE IN MILLIMETERS (ANGLES IN DEGREES).
2. THIS LAND PATTERN IS FOR REFERENCE PURPOSES ONLY. CONSULT YOUR MANUFACTURING GROUP TO ENSURE YOUR COMPANY'S MANUFACTURING GUIDELINES ARE MET.

## Marking Code

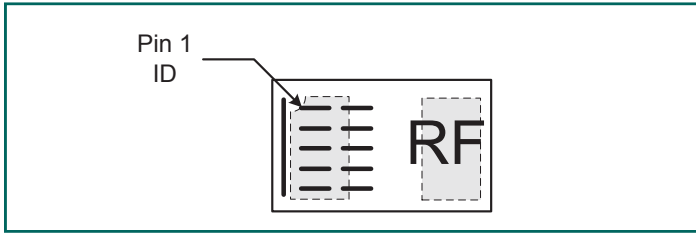

Notes:

- 1) Device is electrically symmetrical
- 2) Dashes indicate line matrix date code
- 3) Bar indicates Pin 1 location

## Tape and Reel Specification

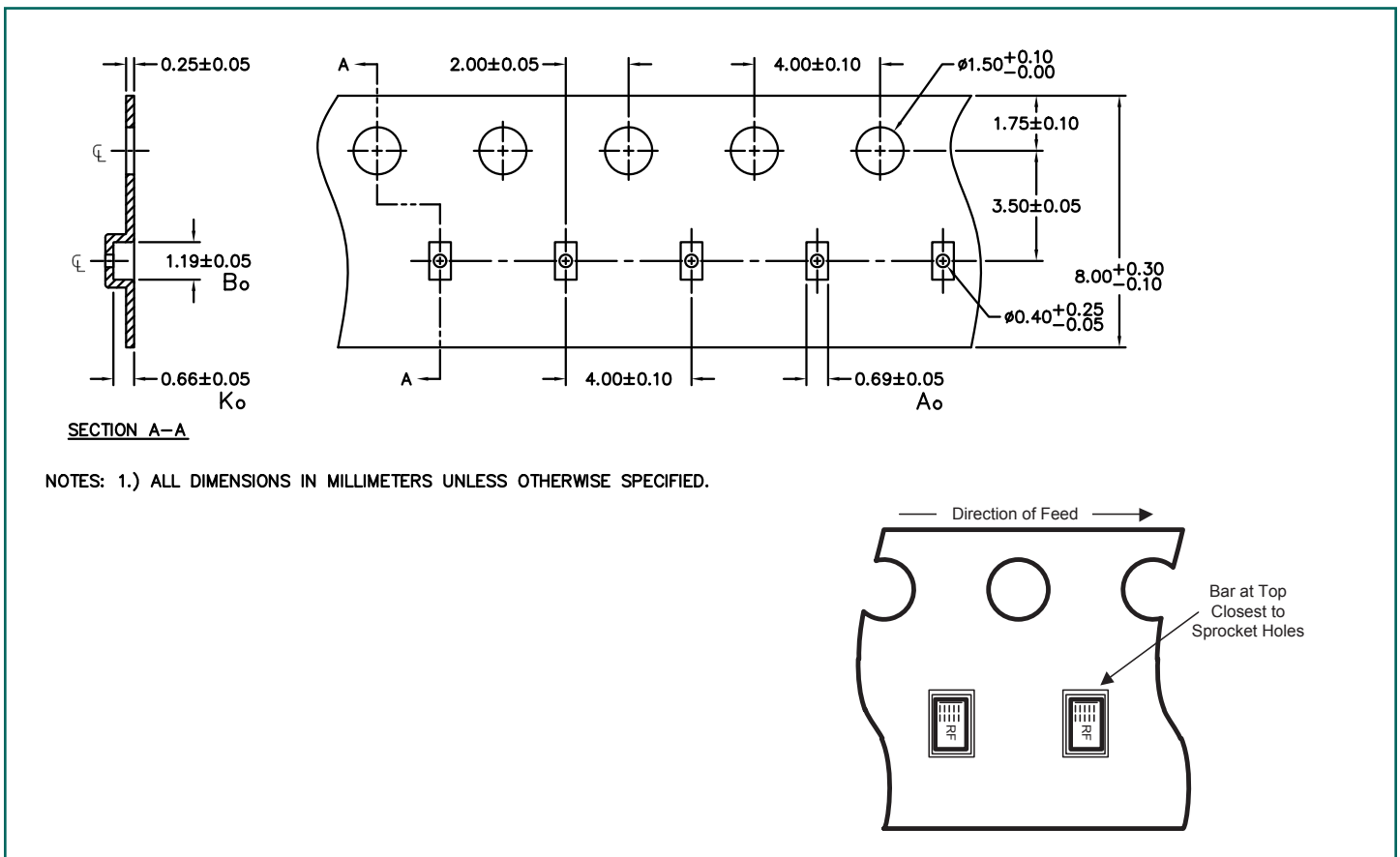

## Ordering Information

Part Number	Qty per Reel	Reel Size
RClamp1561PQTCT	3,000	7 Inch
RailClamp and RClamp are registered trademarks of Semtech Corporation.		



---

#### IMPORTANT NOTICE

Information relating to this product and the application or design described herein is believed to be reliable, however such information is provided as a guide only and Semtech assumes no liability for any errors in this document, or for the application or design described herein. Semtech reserves the right to make changes to the product or this document at any time without notice. Buyers should obtain the latest relevant information before placing orders and should verify that such information is current and complete. Semtech warrants performance of its products to the specifications applicable at the time of sale, and all sales are made in accordance with Semtech's standard terms and conditions of sale.

SEMTECH PRODUCTS ARE NOT DESIGNED, INTENDED, AUTHORIZED OR WARRANTED TO BE SUITABLE FOR USE IN LIFE-SUPPORT APPLICATIONS, DEVICES OR SYSTEMS, OR IN NUCLEAR APPLICATIONS IN WHICH THE FAILURE COULD BE REASONABLY EXPECTED TO RESULT IN PERSONAL INJURY, LOSS OF LIFE OR SEVERE PROPERTY OR ENVIRONMENTAL DAMAGE. INCLUSION OF SEMTECH PRODUCTS IN SUCH APPLICATIONS IS UNDERSTOOD TO BE UNDERTAKEN SOLELY AT THE CUSTOMER'S OWN RISK. Should a customer purchase or use Semtech products for any such unauthorized application, the customer shall indemnify and hold Semtech and its officers, employees, subsidiaries, affiliates, and distributors harmless against all claims, costs damages and attorney fees which could arise.

The Semtech name and logo are registered trademarks of the Semtech Corporation. All other trademarks and trade names mentioned may be marks and names of Semtech or their respective companies. Semtech reserves the right to make changes to, or discontinue any products described in this document without further notice. Semtech makes no warranty, representation or guarantee, express or implied, regarding the suitability of its products for any particular purpose. All rights reserved.

© Semtech 2015

---

#### Contact Information

Semtech Corporation  
200 Flynn Road, Camarillo, CA 93012  
Phone: (805) 498-2111, Fax: (805) 498-3804  
[www.semtech.com](http://www.semtech.com)