

#### PROTECTION PRODUCTS - MicroClamp<sup>®</sup>

#### Description

The  $\mu$ Clamp<sup>®</sup> series of TVS arrays are designed to protect sensitive electronics from damage or latch-up due to ESD. It is designed to replace single line devices such as multilayer varistors (MLVs) in space constrained applications such as cell phones, notebook computers, and other portable electronics. It features large cross-sectional area junctions for conducting high transient currents. TVS diodes offer desirable characteristics for board level protection including fast response time, low operating and clamping voltage, and no device degradation.

The  $\mu$ Clamp<sup>®</sup>0505T is in a 6-pin SLP1313P6T package. It measures 1.3 x 1.3 mm with a nominal height of only 0.4mm. The leads are spaced at a pitch of 0.4mm and are finished with lead-free NiPdAu. Each device features five TVS diodes with an operating voltage of 5 volts and a maximum loading capacitance of only 10pF. They may be used to meet the ESD immunity requirements of IEC 61000-4-2, Level 4 ( $\pm 15$ kV air,  $\pm 8$ kV contact discharge). The combination of small size and high ESD surge capability makes them ideal for use in portable applications such as cellular phones, digital cameras, and notebook computers.

#### Features

- ◆ Transient protection for data lines to **IEC 61000-4-2 (ESD)  $\pm 15$ kV (air),  $\pm 8$ kV (contact)**  
**IEC 61000-4-4 (EFT) 40A (tp = 5/50ns)**  
**Cable Discharge Event (CDE)**
- ◆ Ultra-small package
- ◆ Protects five data lines
- ◆ Low clamping voltage
- ◆ Working voltage: 5V
- ◆ Low capacitance (10pF)
- ◆ Solid-state silicon-avalanche technology

#### Mechanical Characteristics

- ◆ SLP1313P6T package
- ◆ Pb-Free, Halogen Free, RoHS/WEEE Compliant
- ◆ Nominal Dimensions: 1.3 x 1.3 x 0.4 mm
- ◆ Lead Finish: NiPdAu
- ◆ Molding compound flammability rating: UL 94V-0
- ◆ Marking : Marking code
- ◆ Packaging : Tape and Reel

#### Applications

- ◆ Cellular Handsets & Accessories
- ◆ Notebooks & Handhelds
- ◆ mp3 Players
- ◆ Cordless Phones
- ◆ Portable Instrumentation
- ◆ Digital Cameras
- ◆ Peripherals

#### Dimensions

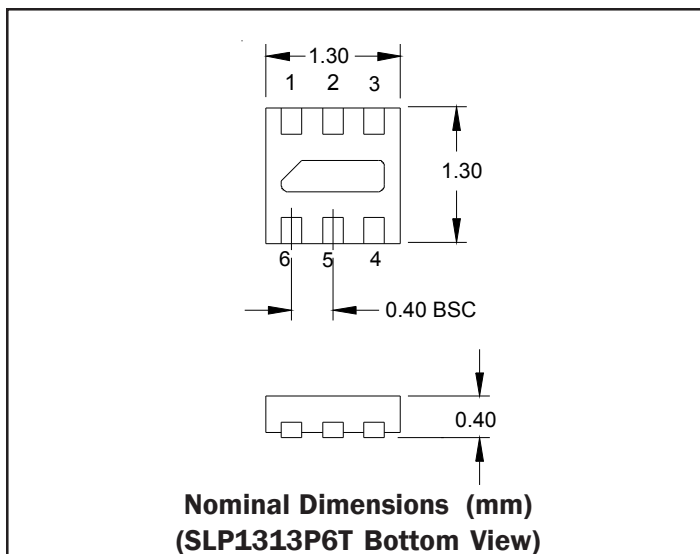

#### Schematic

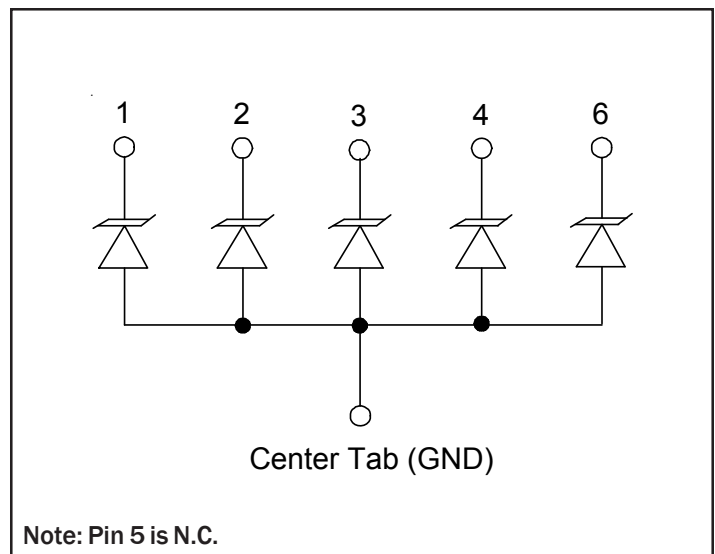

## PROTECTION PRODUCTS

### Absolute Maximum Rating

Rating	Symbol	Value	Units
Peak Pulse Power ( $t_p = 8/20\mu s$ )	$P_{pk}$	25	Watts
Maximum Peak Pulse Current ( $t_p = 8/20\mu s$ )	$I_{pp}$	2	Amps
ESD per IEC 61000-4-2 (Air) ESD per IEC 61000-4-2 (Contact)	$V_{ESD}$	+/- 20 +/- 15	kV
Operating Temperature	$T_J$	-55 to +125	°C
Storage Temperature	$T_{STG}$	-55 to +150	°C

### Electrical Characteristics (T=25°C)

Parameter	Symbol	Conditions	Minimum	Typical	Maximum	Units
Reverse Stand-Off Voltage	$V_{RWM}$				5	V
Reverse Breakdown Voltage	$V_{BR}$	$I_t = 1mA$	6			V
Reverse Leakage Current	$I_R$	$V_{RWM} = 5V, T=25^\circ C$			0.25	$\mu A$
Forward Voltage	$V_F$	$I_F = 10mA$		1	1.2	V
Clamping Voltage	$V_C$	$I_{pp} = 2A, t_p = 8/20\mu s$			12.5	V
Junction Capacitance	$C_j$	$V_R = 0V, f = 1MHz$			10	pF
Junction Capacitance	$C_j$	$V_R = 3.3V, f = 1MHz$		4.5		pF

**PROTECTION PRODUCTS**

Typical Characteristics

**Non-Repetitive Peak Pulse Power vs. Pulse Time**

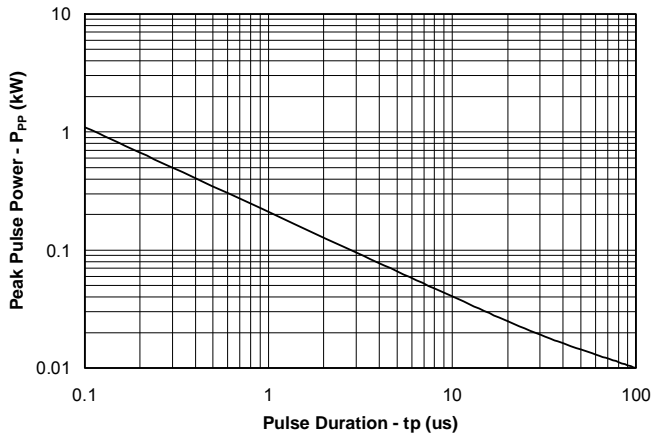

**Power Derating Curve**

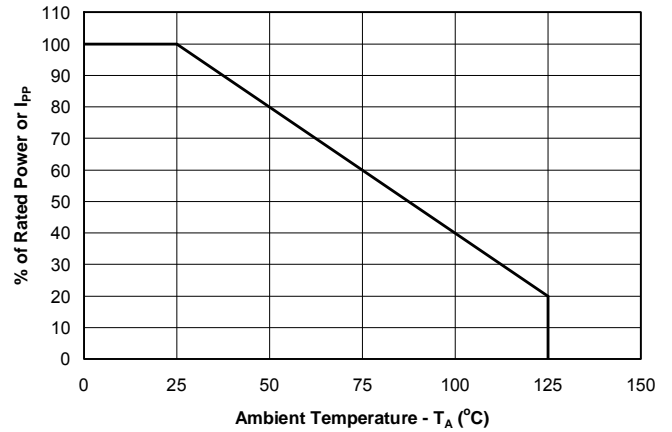

**Clamping Voltage vs. Peak Pulse Current**

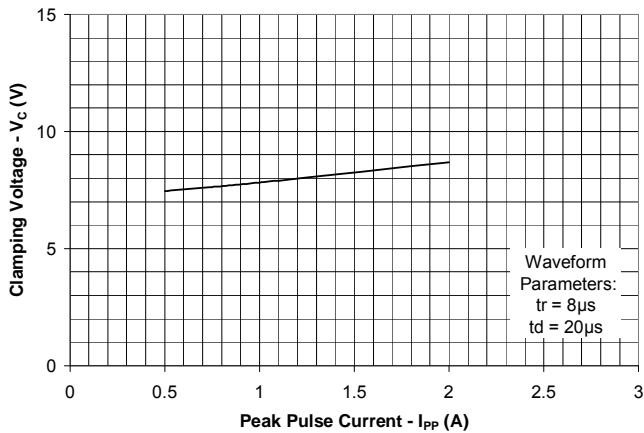

**Forward Voltage vs. Forward Current**

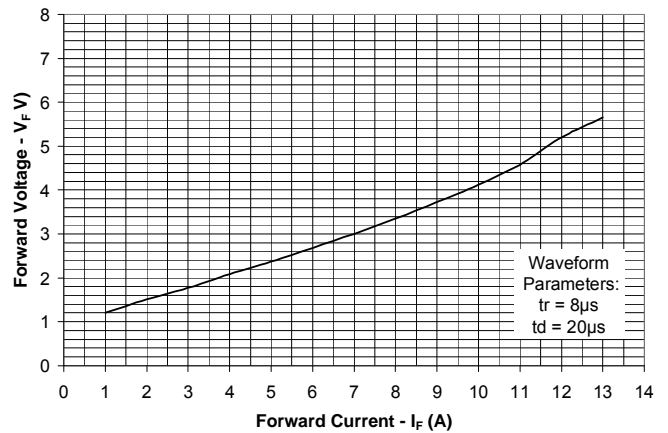

**Normalized Junction Capacitance vs. Reverse Voltage**

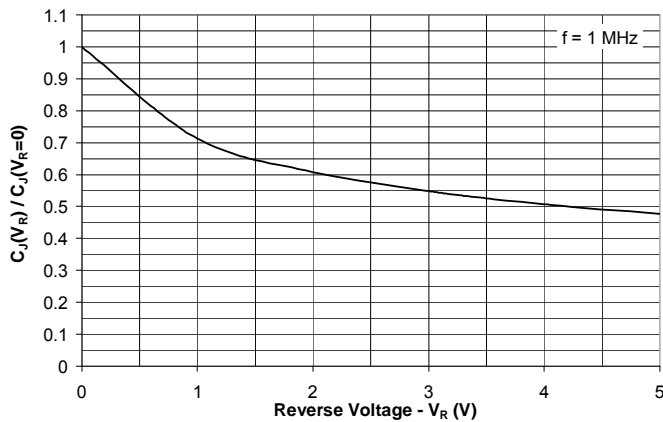

**ESD Clamping  
(8kV Contact per IEC 61000-4-2)**

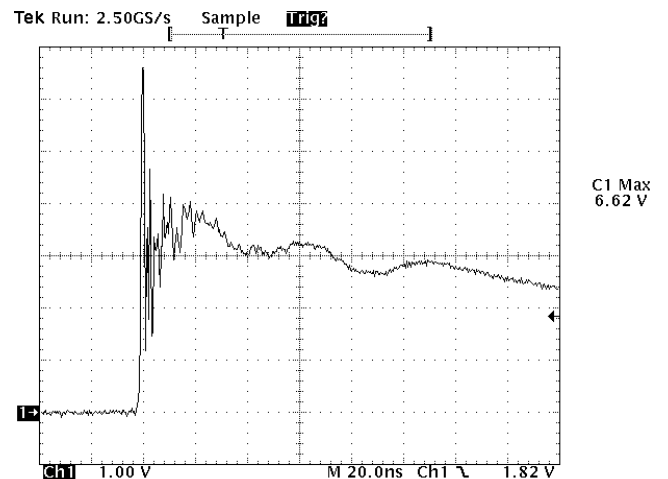

Note: Data is taken with a 10x attenuator

**Device Connection Options**

This device is designed to protect five data lines. The device is unidirectional and may be used on lines where the signal polarity is above ground.

**Circuit Board Layout Recommendations for Suppression of ESD.**

Good circuit board layout is critical for the suppression of ESD induced transients. The following guidelines are recommended:

- Place the TVS near the input terminals or connectors to restrict transient coupling.
- Minimize the path length between the TVS and the protected line.
- Minimize all conductive loops including power and ground loops.
- The ESD transient return path to ground should be kept as short as possible.
- Never run critical signals near board edges.
- Use ground planes whenever possible.

**Circuit Diagram**

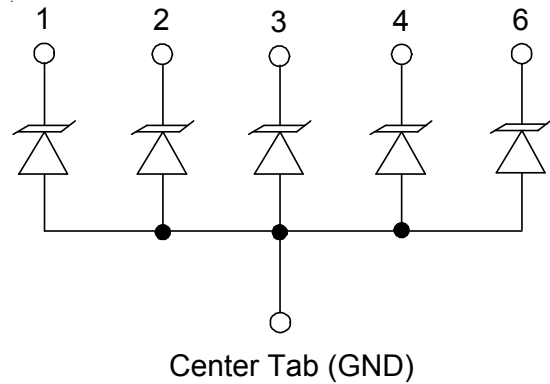

Note: Pin 5 is N.C.

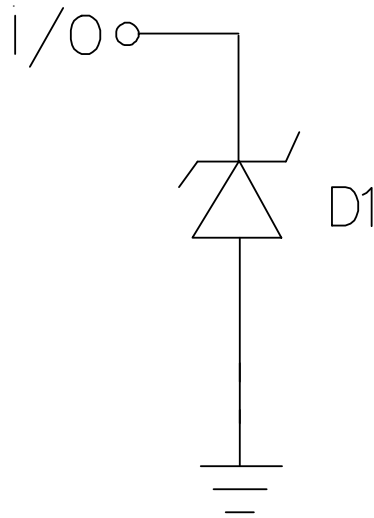

**uClamp0505T Spice Model**

uClamp0505T Spice Parameters		
Parameter	Unit	D1 (TVS)
IS	Amp	2.05e-15
BV	Volt	7.0
VJ	Volt	0.80
RS	Ohm	0.75
IBV	Amp	1.0E-3
CJO	Farad	9e-12
TT	sec	2.541E-9
M	--	0.25
N	--	1.1
EG	eV	1.11

PROTECTION PRODUCTS

Outline Drawing - SLP1313P6T

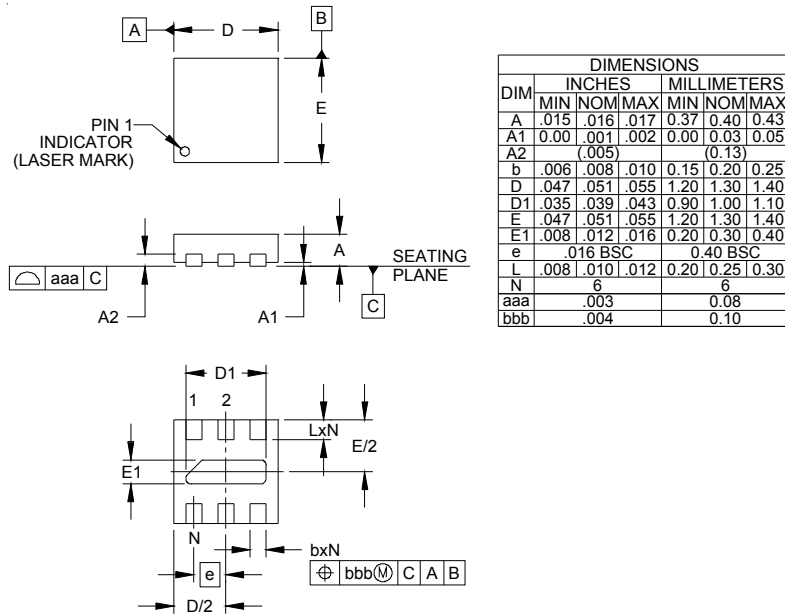

- NOTES:
1. CONTROLLING DIMENSIONS ARE IN MILLIMETERS (ANGLES IN DEGREES).
  2. COPLANARITY APPLIES TO THE EXPOSED PAD AS WELL AS THE TERMINALS.

Land Pattern - SLP1313P6T

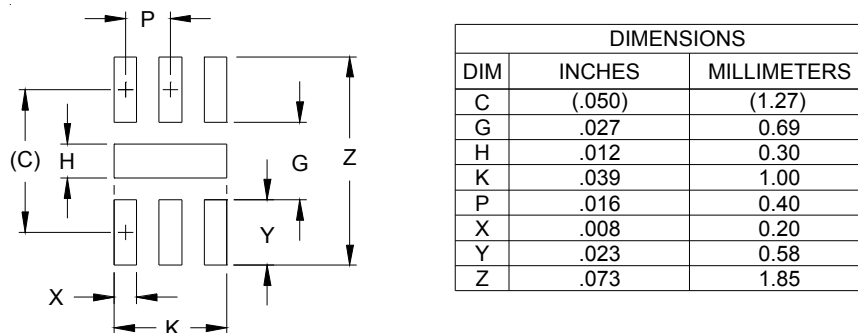

- NOTES:
1. CONTROLLING DIMENSIONS ARE IN MILLIMETERS (ANGLES IN DEGREES).
  2. THIS LAND PATTERN IS FOR REFERENCE PURPOSES ONLY. CONSULT YOUR MANUFACTURING GROUP TO ENSURE YOUR COMPANY'S MANUFACTURING GUIDELINES ARE MET.
  3. THERMAL VIAS IN THE LAND PATTERN OF THE EXPOSED PAD SHALL BE CONNECTED TO A SYSTEM GROUND PLANE. FAILURE TO DO SO MAY COMPROMISE THE THERMAL AND/OR FUNCTIONAL PERFORMANCE OF THE DEVICE.

**PROTECTION PRODUCTS**

**Marking Code**

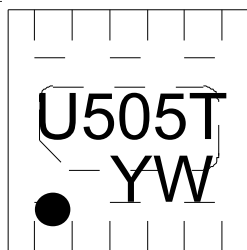

**Ordering Information**

Part Number	Working Voltage	Qty per Reel	Reel Size
uClamp0505T.TCT	5V	3,000	7 Inch

Notes:

1) This is a lead-free, RoHS/WEEE compliant product  
MicroClamp, uClamp and  $\mu$ Clamp are marks of Semtech Corporation

YW = Date Code

**Tape and Reel Specification**

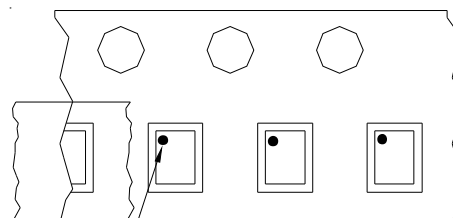
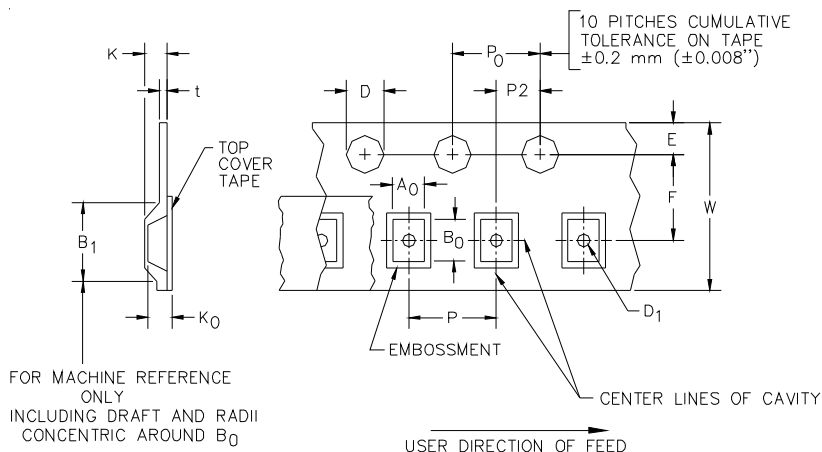

Pin 1 Location

User Direction of feed

**Device Orientation in Tape**

A0	B0	K0
1.51 +/-0.05 mm	1.51 +/-0.05 mm	0.56 +/-0.05 mm

Tape Width	B, (Max)	D	D1	E	F	K (MAX)	P	P0	P2	T(MAX)	W
8 mm	4.2 mm (.165)	1.5 + 0.1 mm - 0.0 mm (0.59 +.005 - .000)	0.8 mm ±0.05 (.031)	1.750±.10 mm (.069±.004)	3.5±0.05 mm (.138±.002)	2.4 mm (.094)	4.0±0.1 mm (.157±.004)	4.0±0.1 mm (.157±.004)	2.0±0.05mm (.079±.002)	0.4 mm (.016)	8.0 mm + 0.3 mm - 0.1 mm (.312±.012)

**Contact Information for Semtech International AG**

**Taiwan Branch**

Tel: 886-2-2748-3380  
Fax: 886-2-2748-3390

**Korea Branch**

Tel: 82-2-527-4377  
Fax: 82-2-527-4376

**Shanghai Office**

Tel: 86-21-6391-0830  
Fax: 86-21-6391-0831

**Semtech Switzerland GmbH  
Japan Branch**

Tel: 81-3-6408-0950  
Fax: 81-3-6408-0951

**Semtech Limited (U.K.)**

Tel: 44-1794-527-600  
Fax: 44-1794-527-601

**Semtech France SARL**

Tel: 33-(0)169-28-22-00  
Fax: 33-(0)169-28-12-98

**Semtech Germany GmbH**

Tel: 49-(0)8161-140-123  
Fax: 49-(0)8161-140-124

Semtech International AG is a wholly-owned subsidiary of Semtech Corporation, which has its headquarters in the U.S.A.