

#### PROTECTION PRODUCTS - MicroClamp™

#### Description

The  $\mu$ Clamp™ series of TVS arrays are designed to protect sensitive electronics from damage or latch-up due to ESD. It is designed to replace multilayer varistors (MLVs) in portable applications such as cell phones, notebook computers, and other portable electronics. It features large cross-sectional area junctions for conducting high transient currents. They offer desirable characteristics for board level protection including fast response time, low operating and clamping voltage, and no device degradation.

The  $\mu$ Clamp™0501T is in a 2-pin, RoHS/WEEE compliant, SLP1006P2T package. It measures 1.0 x 0.6 mm with a nominal height of only 0.4mm. The leads are spaced at a pitch of 0.65mm and are finished with lead-free NiPdAu. Each device will protect one line operating at 5 volts. It gives the designer the flexibility to protect single lines in applications where arrays are not practical. They may be used to meet the ESD immunity requirements of IEC 61000-4-2, Level 4 ( $\pm 15$ kV air,  $\pm 8$ kV contact discharge). The combination of small size and high ESD surge capability makes them ideal for use in portable applications such as cellular phones, digital cameras, and MP3 players.

#### Features

- ◆ Transient protection for data lines to **IEC 61000-4-2 (ESD)  $\pm 15$ kV (air),  $\pm 8$ kV (contact)**  
**IEC 61000-4-4 (EFT) 40A (tp = 5/50ns)**  
**Cable Discharge Event (CDE)**
- ◆ Ultra-small package (1.0 x 0.6 x 0.4mm)
- ◆ Protects one data line
- ◆ Low clamping voltage
- ◆ Working voltage: 5V
- ◆ Low leakage current
- ◆ Solid-state silicon-avalanche technology

#### Mechanical Characteristics

- ◆ SLP1006P2T package
- ◆ RoHS/WEEE Compliant
- ◆ Nominal Dimensions: 1.0 x 0.6 x 0.4 mm
- ◆ Lead Finish: NiPdAu
- ◆ Molding compound flammability rating: UL 94V-0
- ◆ Marking : Marking code, cathode band
- ◆ Packaging : Tape and Reel

#### Applications

- ◆ Cellular Handsets & Accessories
- ◆ Personal Digital Assistants (PDAs)
- ◆ Notebooks & Handhelds
- ◆ Portable Instrumentation
- ◆ Digital Cameras
- ◆ Peripherals
- ◆ MP3 Players

#### Dimensions

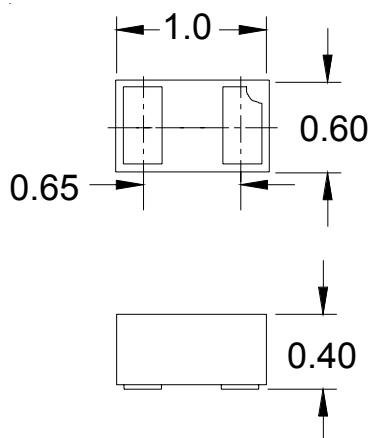

**Nominal Dimensions (mm)**

#### Schematic & PIN Configuration

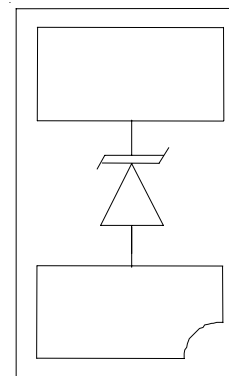

**SLP1006P2T (Bottom View)**

## PROTECTION PRODUCTS

### Absolute Maximum Rating

Rating	Symbol	Value	Units
Peak Pulse Power ( $t_p = 8/20\mu s$ )	$P_{pk}$	25	Watts
Maximum Peak Pulse Current ( $t_p = 8/20\mu s$ )	$I_{pp}$	2	Amps
ESD per IEC 61000-4-2 (Air) ESD per IEC 61000-4-2 (Contact)	$V_{ESD}$	+/- 20 +/- 15	kV
Operating Temperature	$T_J$	-55 to +125	°C
Storage Temperature	$T_{STG}$	-55 to +150	°C

### Electrical Characteristics (T=25°C)

Parameter	Symbol	Conditions	Minimum	Typical	Maximum	Units
Reverse Stand-Off Voltage	$V_{RWM}$				5	V
Reverse Breakdown Voltage	$V_{BR}$	$I_t = 1mA$	6			V
Reverse Leakage Current	$I_R$	$V_{RWM} = 5V, T=25^\circ C$			0.25	$\mu A$
Forward Voltage	$V_F$	$I_F = 10mA$		1	1.2	V
Clamping Voltage	$V_C$	$I_{pp} = 2A, t_p = 8/20\mu s$			12.5	V
Junction Capacitance	$C_j$	$V_R = 0V, f = 1MHz$			10	pF
Junction Capacitance	$C_j$	$V_R = 3.3V, f = 1MHz$		4.5		pF

**PROTECTION PRODUCTS**

Typical Characteristics

**Non-Repetitive Peak Pulse Power vs. Pulse Time**

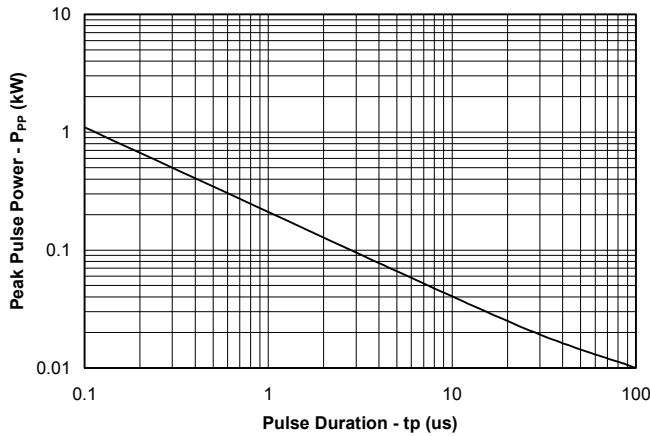

**Power Derating Curve**

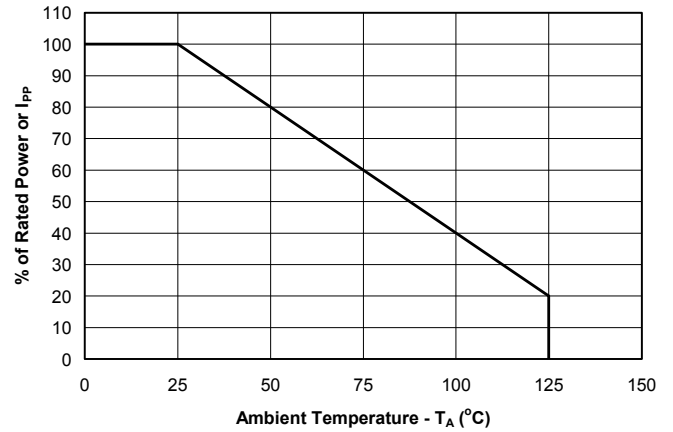

**Clamping Voltage vs. Peak Pulse Current**

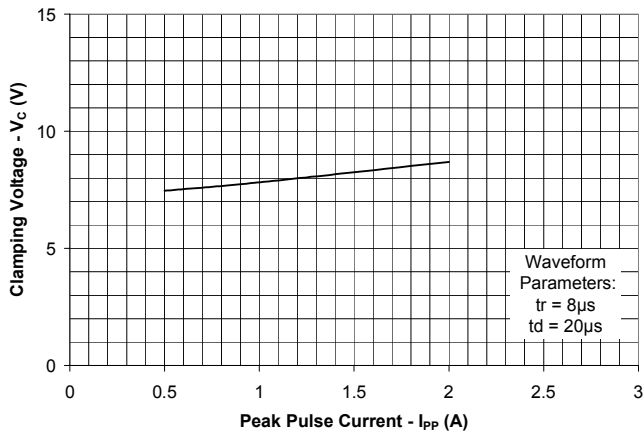

**Forward Voltage vs. Forward Current**

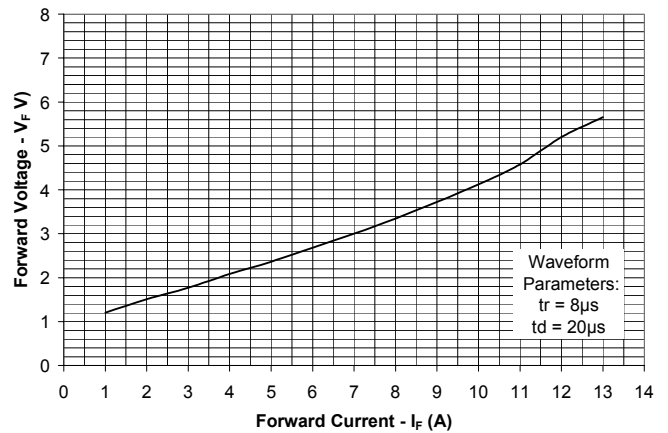

**Junction Capacitance vs. Reverse Voltage**

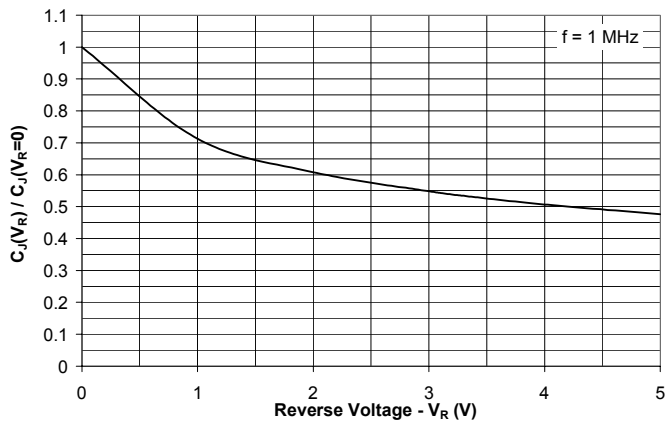

**ESD Clamping  
(8kV Contact per IEC 61000-4-2)**

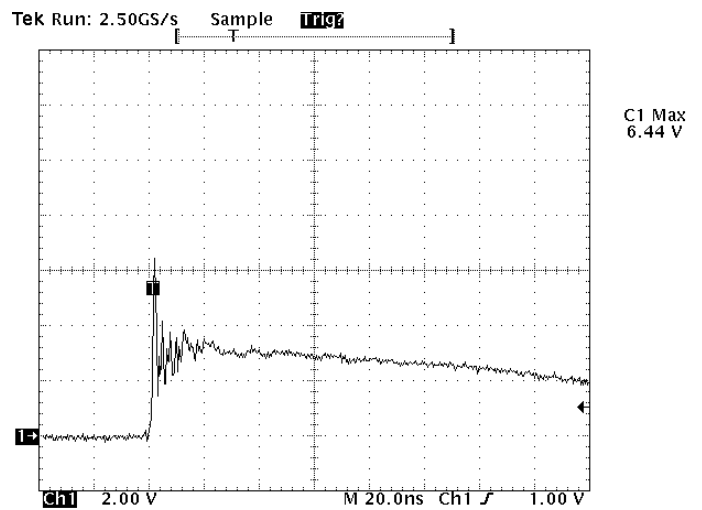

Note: Data is taken with a 10x attenuator

Typical Characteristics

**Insertion Loss S21**

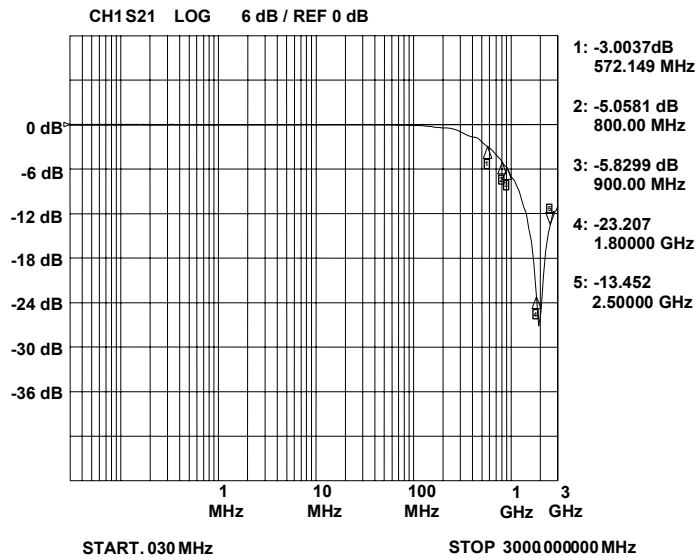

**PROTECTION PRODUCTS****Applications Information****Device Connection Options**

This device is designed to protect one data or power supply line. The device is unidirectional and may be used on lines where the signal polarity is above ground. The cathode band should be placed towards the line that is to be protected.

**Circuit Board Layout Recommendations for Suppression of ESD.**

Good circuit board layout is critical for the suppression of ESD induced transients. The following guidelines are recommended:

- Place the TVS near the input terminals or connectors to restrict transient coupling.
- Minimize the path length between the TVS and the protected line.
- Minimize all conductive loops including power and ground loops.
- The ESD transient return path to ground should be kept as short as possible.
- Never run critical signals near board edges.
- Use ground planes whenever possible.

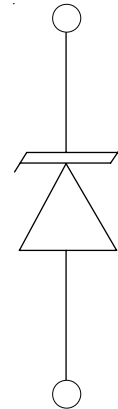
**Circuit Diagram**

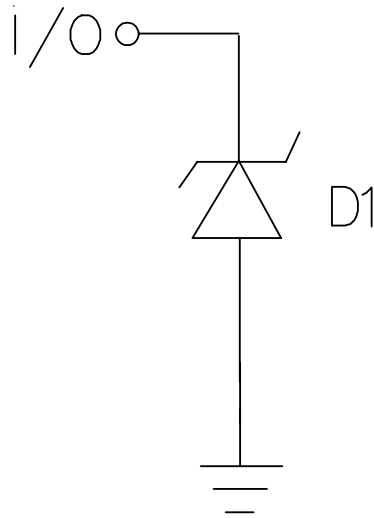

**uClamp0501T Spice Model**

uClamp0501T Spice Parameters		
Parameter	Unit	D1 (TVS)
IS	Amp	2.05e-15
BV	Volt	7.0
VJ	Volt	0.80
RS	Ohm	0.75
IBV	Amp	1.0E-3
CJO	Farad	9e-12
TT	sec	2.541E-9
M	--	0.25
N	--	1.1
EG	eV	1.11

**PROTECTION PRODUCTS**

**Outline Drawing - SLP1006P2T**

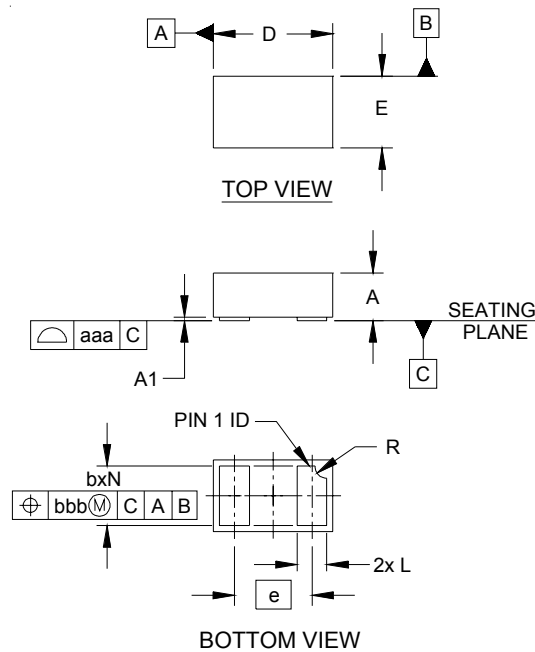

DIM	DIMENSIONS					
	INCHES			MILLIMETERS		
	MIN	NOM	MAX	MIN	NOM	MAX
A	.015	.016	.017	0.37	0.40	0.43
A1	.000	.001	.002	0.00	0.03	0.05
b	.018	.020	.022	0.45	0.50	0.55
D	.035	.039	.043	0.90	1.00	1.10
E	.020	.024	.028	0.50	0.60	0.70
e	.026 BSC			0.65 BSC		
L	.008	.010	.012	0.20	0.25	0.30
R	.002	.004	.006	0.05	0.10	0.15
N	2			2		
aaa	.003			0.08		
bbb	.004			0.10		

**NOTES:**

1. CONTROLLING DIMENSIONS ARE IN MILLIMETERS (ANGLES IN DEGREES).

**Land Pattern - SLP1006P2T**

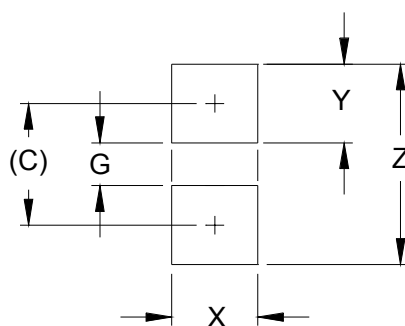

DIM	DIMENSIONS	
	INCHES	MILLIMETERS
C	(.033)	(0.85)
G	.012	0.30
X	.024	0.60
Y	.022	0.55
Z	.055	1.40

**NOTES:**

1. CONTROLLING DIMENSIONS ARE IN MILLIMETERS (ANGLES IN DEGREES).
2. THIS LAND PATTERN IS FOR REFERENCE PURPOSES ONLY. CONSULT YOUR MANUFACTURING GROUP TO ENSURE YOUR COMPANY'S MANUFACTURING GUIDELINES ARE MET.

**PROTECTION PRODUCTS**

**Marking Code**

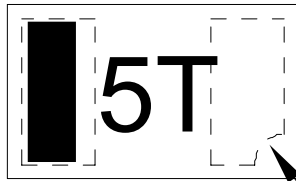

PIN 1 ID

**Ordering Information**

Part Number	Working Voltage	Qty per Reel	Reel Size
uClamp0501T.TCT	5V	3,000	7 Inch

Notes:

1) This is a lead-free, RoHS/WEEE compliant product  
MicroClamp, uClamp and  $\mu$ Clamp are marks of Semtech Corporation

**Tape and Reel Specification**

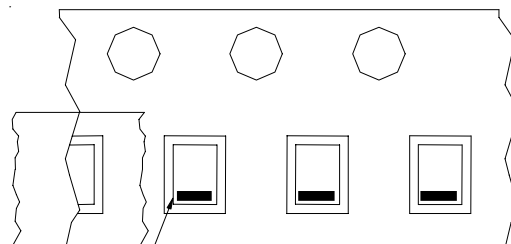
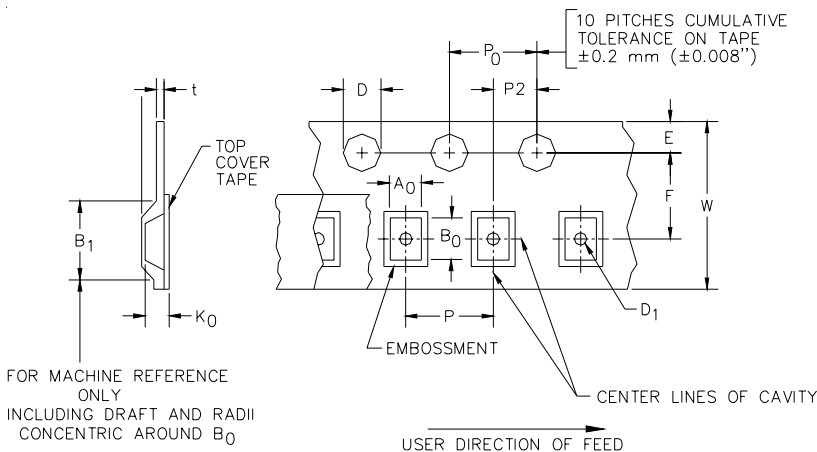

Cathode Bar

User Direction of feed

Device Orientation in Tape

A0	B0	K0
0.69 +/-0.10 mm	1.19 +/-0.10 mm	0.66 +/-0.10 mm

Tape Width	B, (Max)	D	D1	E	F	P	P0	P2	T	W
8 mm	4.2 mm (.165)	1.5 + 0.1 mm - 0.0 mm (0.59 +.005 -.000)	0.4 mm ±0.25 (.031)	1.750±.10 mm (.069±.004)	3.5±0.05 mm (.138±.002)	4.0±0.10 mm (.157±.004)	4.0±0.1 mm (.157±.004)	2.0±0.05 mm (.079±.002)	0.254±0.02 mm (.016)	8.0 mm + 0.3 mm - 0.1 mm (.312±.012)

**Contact Information for Semtech International AG**

<b>Taiwan Branch</b>	Tel: 886-2-2748-3380 Fax: 886-2-2748-3390	<b>Semtech Switzerland GmbH</b>	Tel: 81-3-6408-0950 Fax: 81-3-6408-0951
<b>Korea Branch</b>	Tel: 82-2-527-4377 Fax: 82-2-527-4376	<b>Semtech Japan Branch</b>	
<b>Shanghai Office</b>	Tel: 86-21-6391-0830 Fax: 86-21-6391-0831	<b>Semtech Limited (U.K.)</b>	Tel: 44-1794-527-600 Fax: 44-1794-527-601
		<b>Semtech France SARM</b>	Tel: 33-(0)169-28-22-00 Fax: 33-(0)169-28-12-98
		<b>Semtech Germany GmbH</b>	Tel: 49-(0)8161-140-123 Fax: 49-(0)8161-140-124

Semtech International AG is a wholly-owned subsidiary of Semtech Corporation, which has its headquarters in the U.S.A.