

PROTECTION PRODUCTS - TransClamp™

Description

A TransClamp™ is a low capacitance TVS array designed to protect high speed data interfaces. This series has been specifically designed to protect sensitive components which are connected to data and transmission lines from overvoltage caused by **ESD** (electrostatic discharge), **CDE** (Cable Discharge Events), and **Lightning**.

These devices integrate low capacitance, surge-rated compensation diodes with a high power transient voltage suppressor (TVS). The compensation diodes are arranged in a bridge pattern allowing the device to be connected in common mode and/or differential mode. This allows the designer maximum flexibility and reduces parts count. The capacitance of the device is limited to 12pF maximum from line-to-line to ensure correct signal transmission on high-speed lines.

These devices may be used to meet Bellcore GR-1089-CORE short-haul (intra-building) surge requirements and will withstand a minimum 100 A surge for a 2/10µs pulse.

The TClamp™0602N is in a 10-pin, RoHS/WEEE compliant, SLP2626P10 package. It measures 2.6 x 2.6 x 0.60mm. The leads are spaced at a pitch of 0.5mm and are finished with lead-free NiPdAu. They are particularly well suited for applications where board space is at a premium such as integrated connectors/magnetics and T1/E1 equipment.

Features

- ◆ Transient protection for high-speed data lines to **Bellcore 1089 (Intra-Building) 100A (2/10µs)**
IEC 61000-4-2 (ESD) ±15kV (air), ±8kV (contact)
IEC 61000-4-4 (EFT) 40A (5/50ns)
IEC 61000-4-5 (Lightning) L5, 95A (8/20µs)
- ◆ Protects two lines in common and differential mode
- ◆ Low capacitance (12pF line-to-line)
- ◆ Low operating voltages (6V)
- ◆ Low clamping voltage
- ◆ Small SLP Package saves board space
- ◆ Solid-state technology

Mechanical Characteristics

- ◆ SLP2626P10 10L package
- ◆ RoHS/WEEE Compliant
- ◆ Nominal Dimensions: 2.6 x 2.6 x 0.60 mm
- ◆ Lead Pitch: 0.5mm
- ◆ Molding compound flammability rating: UL 94V-0
- ◆ Marking: Marking Code
- ◆ Packaging: Tape and Reel

Applications

- ◆ T1/E1
- ◆ T3/E3
- ◆ 10/100 Ethernet
- ◆ Integrated Magnetics
- ◆ Carrier Class Equipment
- ◆ ISDN Interfaces

Circuit Diagram

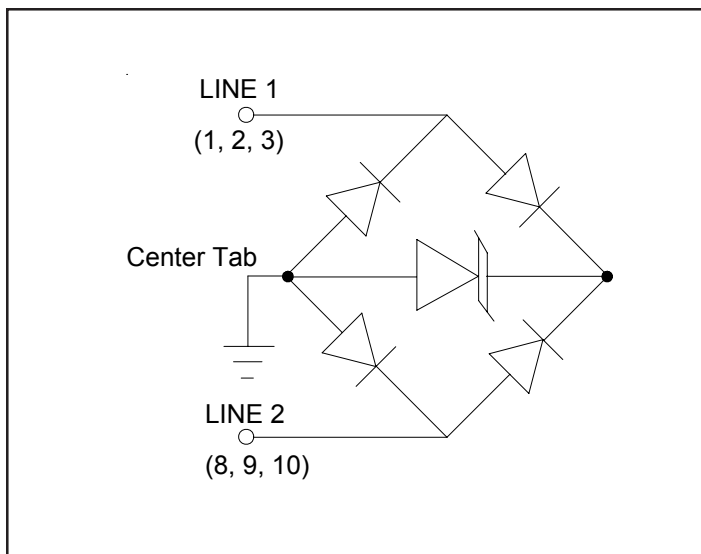

Package Configuration

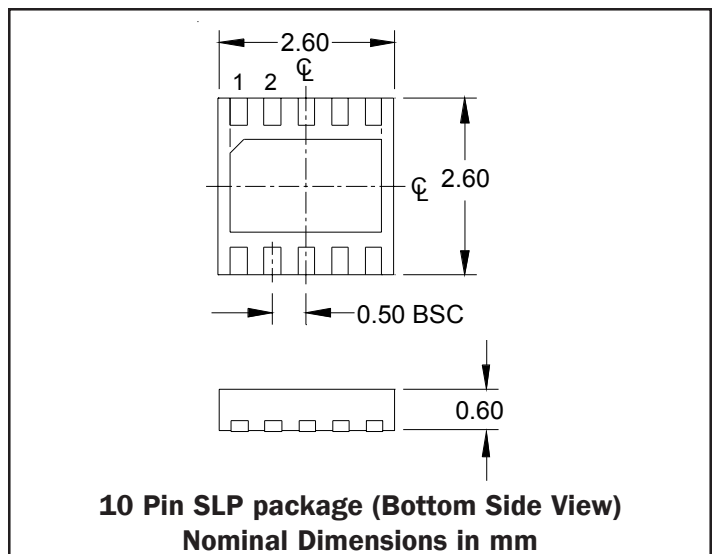

PROTECTION PRODUCTS

Absolute Maximum Rating

Rating	Symbol	Value	Units
Peak Pulse Power (tp = 8/20μs)	P_{pk}	2500	Watts
Peak Pulse Current (tp = 2/10μs)	I_{pp}	120	A
Peak Pulse Current (tp = 8/20μs)	I_{pp}	95	A
ESD per IEC 61000-4-2 (Air) ESD per IEC 61000-4-2 (Contact)	V_{ESD}	30 30	kV
Operating Temperature	T_J	-55 to +125	°C
Storage Temperature	T_{STG}	-55 to +150	°C

Electrical Characteristics (T=25°C)

TClamp0602N						
Parameter	Symbol	Conditions	Minimum	Typical	Maximum	Units
Reverse Stand-Off Voltage	V_{RWM}				6	V
Reverse Breakdown Voltage	V_{BR}	$I_t = 1mA$	6.8			V
Reverse Leakage Current	I_R	$V_{RWM} = 6V, T=25^\circ C$			5	μA
Clamping Voltage	V_C	$I_{pp} = 100A, tp = 2/10\mu s$ Line-to-Ground			25	V
Clamping Voltage	V_C	$I_{pp} = 100A, tp = 2/10\mu s$ Line-to-Line			29	V
Junction Capacitance	C_J	Line-to-Gnd $V_R = 0V, f = 1MHz$			25	pF
		Line-to-Line $V_R = 0V, f = 1MHz$			12	pF

PROTECTION PRODUCTS

Typical Characteristics

Non-Repetitive Peak Pulse Power vs. Pulse Time

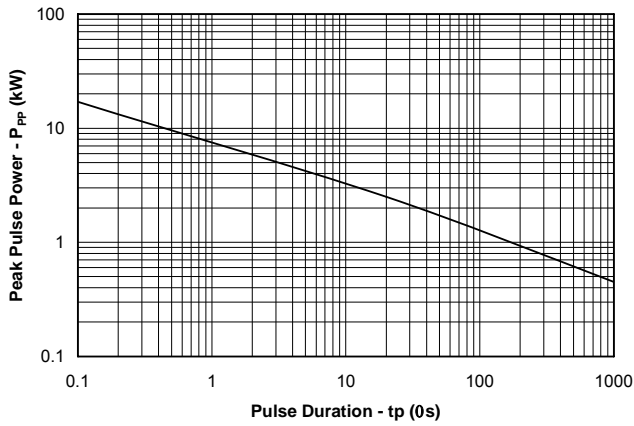

Power Derating Curve

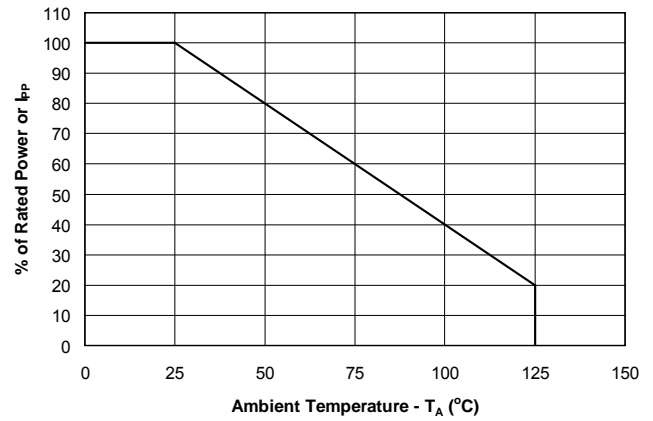

Clamping Voltage vs. Peak Pulse Current Line-to-Ground

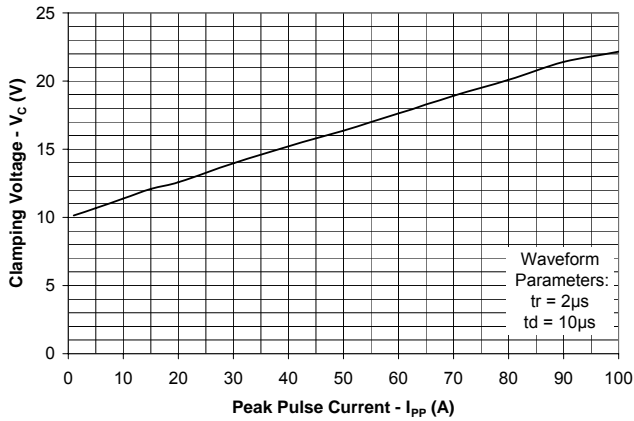

Clamping Voltage vs. Peak Pulse Current Line-to-Line

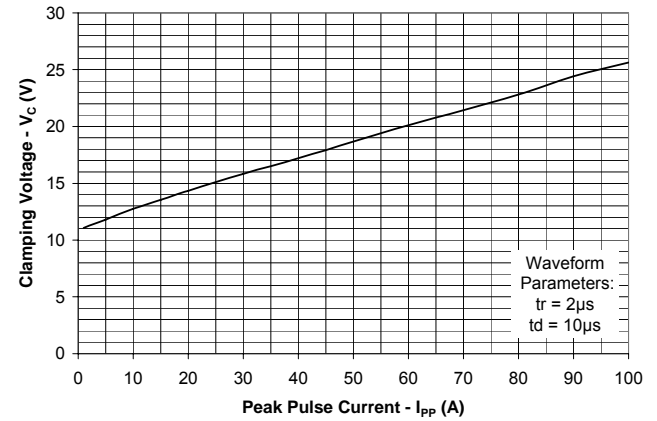

Normalized Junction Capacitance vs. Reverse Voltage

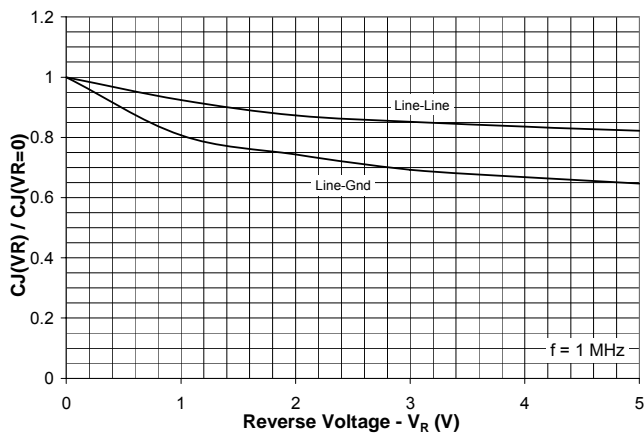

PROTECTION PRODUCTS

Applications Information

Device Connection Options for Protection of Two High-Speed Data Lines

These devices are designed to protect two high-speed data lines (one differential pair) from transient over-voltages which result from lightning and ESD. They can be configured to protect in differential (Line-to-Line) and common (Line-to-Ground) mode. Data line inputs/outputs are connected at pins 1, 2 and 3, and 8, 9 and 10 as shown. For proper operation, pins 1 - 3 must be connected together and pins 8 - 10 must be connected together. Pins 4, 5, 6, and 7 left unconnected. For differential operation, the center tab is also left not connected. For common mode operation, the center tab is connected to ground. The ground connection should be made directly to a ground plane on the board for best results. The use of multiple vias is recommended for reduced ground loop inductance.

Circuit Diagram

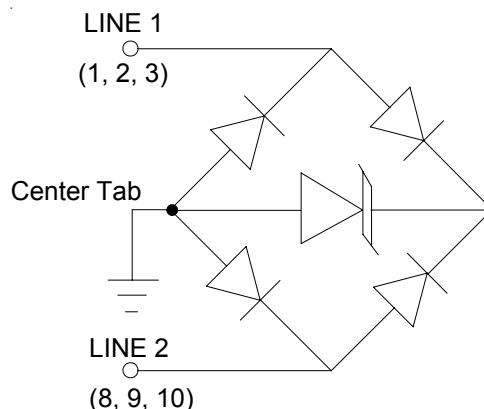

Pin Configuration (Top Side View)

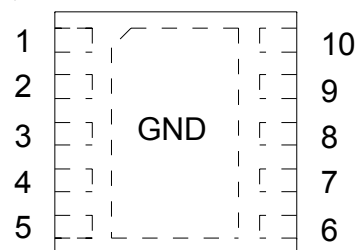

Pin	Identification
1, 2, 3	Line 1 in/out
8, 9, 10	Line 2 in/out
4, 5, 6, 7	No Connect
Center Tab	Ground

PROTECTION PRODUCTS

Applications Information - Spice Model

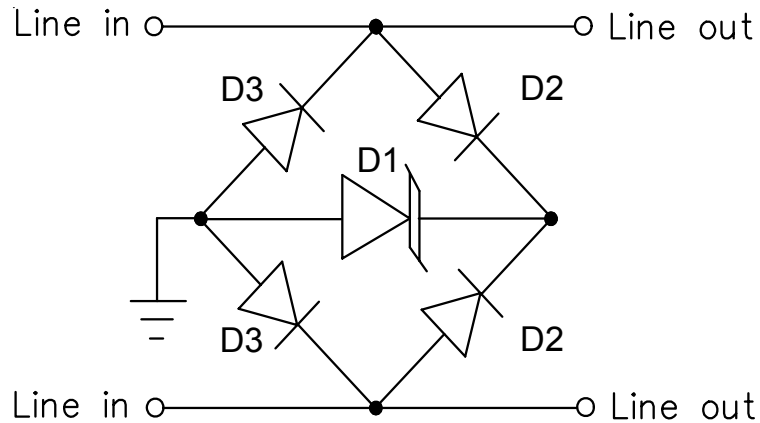

TClamp0602N Spice Model

TClamp0602N Spice Parameters				
Parameter	Unit	D1 (TVS)	D2 (LCRD)	D3 (LCRD)
IS	Amp	1.4E-11	1.001E-20	1.001E-20
BV	Volt	8.3	150	150
VJ	Volt	0.56	0.59	0.59
RS	Ohm	0.029	0.075	0.064
IBV	Amp	1E-3	1E-3	1E-3
CJO	Farad	300e-12	11.0E-12	11.0E-12
TT	sec	2.541E-9	2.541E-9	2.541E-9
M	--	0.256	0.01	0.01
N	--	1.1	1.1	1.1
EG	eV	1.11	1.11	1.11

PROTECTION PRODUCTS

Outline Drawing - SLP2626P10

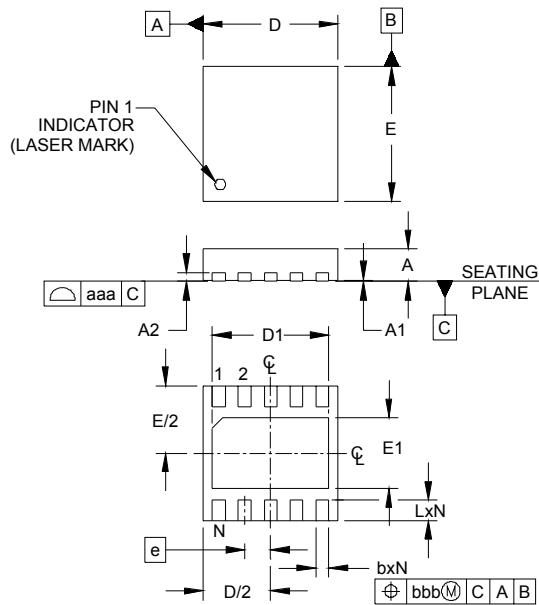

DIM	DIMENSIONS					
	INCHES			MILLIMETERS		
	MIN	NOM	MAX	MIN	NOM	MAX
A	.020	.024	.026	0.50	0.60	0.65
A1	.000	.001	.002	0.00	0.03	0.05
A2	(.007)			(0.17)		
b	.007	.010	.012	0.20	0.25	0.30
D	.098	.102	.106	2.50	2.60	2.70
D1	.079	.085	.089	2.00	2.15	2.25
E	.098	.102	.106	2.50	2.60	2.70
E1	.044	.050	.054	1.11	1.26	1.36
e	.020 BSC			0.50 BSC		
L	.011	.014	.016	0.30	0.35	0.40
N	10			10		
aaa	.003			0.08		
bbb	.004			0.10		

NOTES:

1. CONTROLLING DIMENSIONS ARE IN MILLIMETERS (ANGLES IN DEGREES).
2. COPLANARITY APPLIES TO THE EXPOSED PAD AS WELL AS THE TERMINALS.

Land Pattern - SLP2626P10

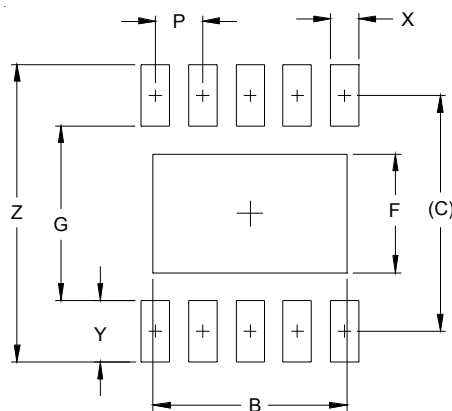

DIM	DIMENSIONS	
	INCHES	MILLIMETERS
B	.081	2.05
C	.100	2.50
F	.050	1.26
G	.073	1.85
P	.020	0.50
X	.012	0.30
Y	.025	0.65
Z	.124	3.15

NOTES:

1. THIS LAND PATTERN IS FOR REFERENCE PURPOSES ONLY. CONSULT YOUR MANUFACTURING GROUP TO ENSURE YOUR COMPANY'S MANUFACTURING GUIDELINES ARE MET.

PROTECTION PRODUCTS

Marking

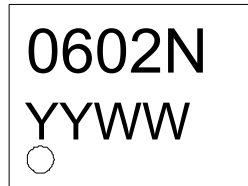

YY = year
WW = Week

Ordering Information

Part Number	Qty per Reel	Reel Size
TClamp0602N.TCT	3,000	7 Inch

Note: Lead finish is lead-free NiPdAu

TransClamp and TClamp are marks of Semtech Corporation

Tape and Reel Specification

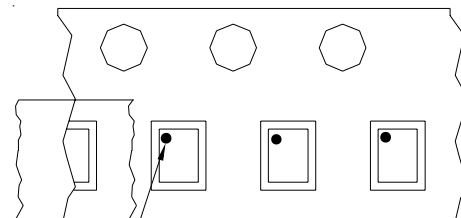
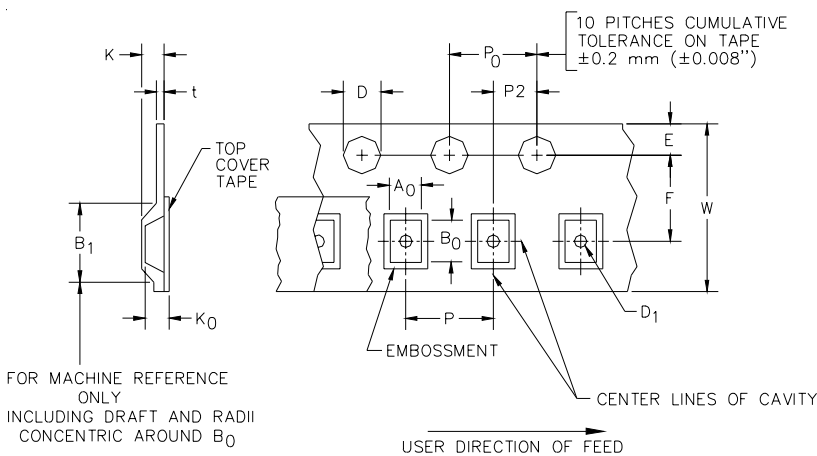

Pin 1 Location

User Direction of feed

Device Orientation in Tape

A0	B0	K0
2.77 +/-0.05 mm	2.77 +/-0.05 mm	0.80 +/-0.05 mm

Tape Width	B, (Max)	D	D1	E	F	K (MAX)	P	P0	P2	T(MAX)	W
8 mm	4.2 mm (.165)	1.5 + 0.1 mm - 0.0 mm	1.0 mm ±0.05	1.750±.10 mm	3.5±0.05 mm	2.4 mm	4.0±0.1 mm	4.0±0.1 mm	2.0±0.05 mm	0.4 mm	8.0 mm + 0.3 mm - 0.1 mm

Contact Information for Semtech International AG

Taiwan Branch	Tel: 886-2-2748-3380 Fax: 886-2-2748-3390	Semtech Switzerland GmbH	Tel: 81-3-6408-0950 Fax: 81-3-6408-0951
Korea Branch	Tel: 82-2-527-4377 Fax: 82-2-527-4376	Japan Branch	
Shanghai Office	Tel: 86-21-6391-0830 Fax: 86-21-6391-0831	Semtech Limited (U.K.)	Tel: 44-1794-527-600 Fax: 44-1794-527-601
		Semtech France SARL	Tel: 33-(0)169-28-22-00 Fax: 33-(0)169-28-12-98
		Semtech Germany GmbH	Tel: 49-(0)8161-140-123 Fax: 49-(0)8161-140-124

Semtech International AG is a wholly-owned subsidiary of Semtech Corporation, which has its headquarters in the U.S.A.