

POWER MANAGEMENT

Description

The SC614 is a high efficiency charge pump LED driver using Semtech's proprietary mAHLife™ technology. Performance is optimized for use in Li-ion battery applications.

Each of 7 LED currents can be programmed via the I²C serial control bus. M1 through M4 are for LED backlighting of LCD main displays. S1/FL3 through S3/FL1 can be used for backlighting sub displays and/or for driving flash LEDs. These three current sinks are configurable over the I²C interface for any combination of pins for sub or flash use.

The charge pump automatically selects an operating mode based on the number of active loads, input voltage, and load currents required. Any combination of LED drivers can be enabled at one time, allowing the SC614 to power any combination of backlight and flash required by the application.

Two dedicated pins, MDIM and SDIM, are provided to allow PWM dimming of the main and sub-backlights and one dedicated pin, FL, allows direct control of the flash. All three pins can be utilized without having to use the I²C interface once the registers are set up.

The enable pin can be used to put the device in low-current shutdown mode drawing 0.1µA (typ), or a register can be written that sets the device in a sleep mode that reduces the current to 50µA (typ).

Features

- ◆ Four independent current sinks for main backlight, adjustable from 0.4mA to 32mA each
- ◆ Dedicated MDIM pin for PWM dimming of main backlight
- ◆ Three independent current sinks for sub-backlight or flash, adjustable from 0.4mA to 102mA each
- ◆ Configurable sub-backlight or flash sinks
- ◆ Dedicated SDIM pin for PWM dimming of sub-backlight
- ◆ Dedicated FL pin for flash control
- ◆ Current accuracy to within ±1.5% down to 4.8mA
- ◆ Current matching to within ±0.5% down to 4.8mA
- ◆ Very high efficiency over 90% of battery life
- ◆ Shutdown current 0.1µA (typ)
- ◆ Three charge pump operating modes: 1x, 1.5x, and 2x
- ◆ I²C serial interface
- ◆ Soft-start/in-rush current limiting
- ◆ 1.33MHz and 250kHz programmable fixed frequency options
- ◆ Short-circuit/thermal protection
- ◆ Output open circuit protection
- ◆ MLPQ-24 package (4mm x 4mm), fully WEEE and RoHS compliant

Applications

- ◆ Cellular phone backlighting and flash
- ◆ LCD modules
- ◆ PDA backlighting and flash
- ◆ RGB LED Driver

Typical Application Circuit

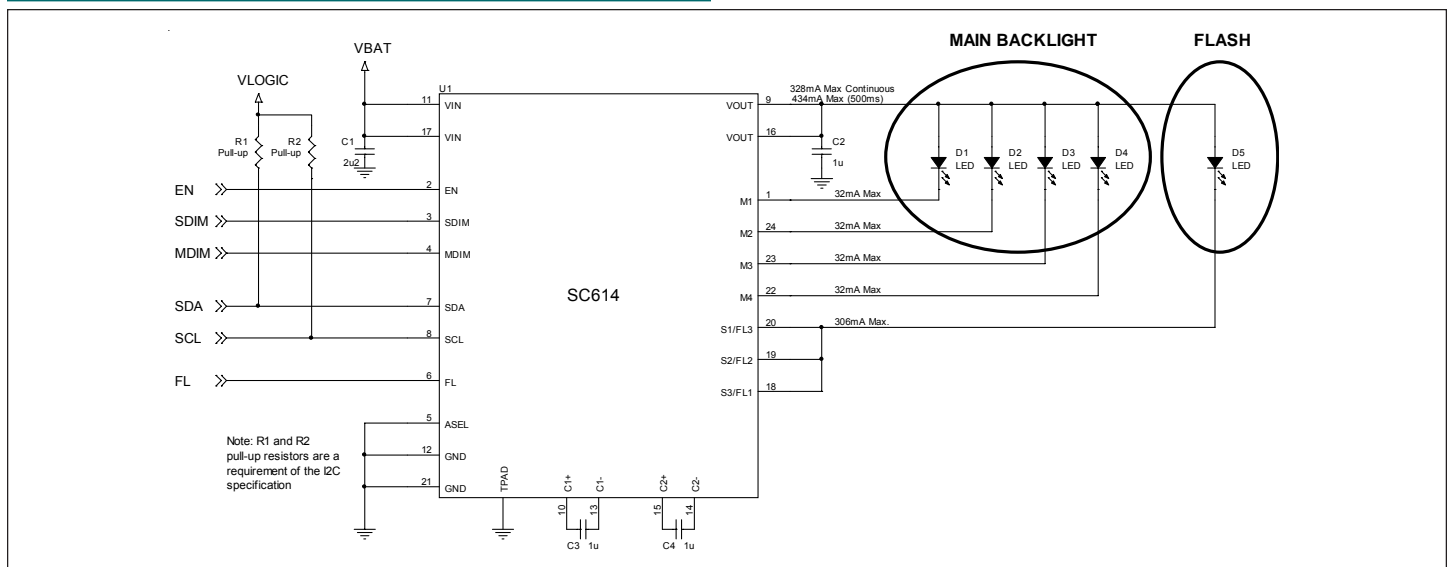

POWER MANAGEMENT
Absolute Maximum Ratings

Exceeding the specifications below may result in permanent damage to the device or device malfunction. Operation outside of the parameters specified in the Electrical Characteristics section is not implied. Exposure to Absolute Maximum rated conditions for extended periods of time may affect device reliability.

Parameter	Symbol	Maximum	Units
Supply Voltage	V_{IN}	-0.3 to 6.5	V
Output Voltage	V_{OUT}	-0.3 to 6.5	V
Pin Voltage - C1+, C2+		-0.3 to $V_{OUT} + 0.3$	V
Pin Voltage - All other pins		-0.3 to $V_{IN} + 0.3$	V
V_{OUT} Short Circuit Duration	t_{SC}	Indefinite	s
Thermal Resistance, Junction to Ambient ⁽¹⁾	θ_{JA}	40	°C/W
Operating Ambient Temperature Range	T_A	-40 to +85	°C
Junction Temperature Range	T_J	-40 to +150	°C
Storage Temperature Range	T_{STG}	-65 to +150	°C
IR Reflow (Soldering) 10s to 30s	T_{LEAD}	260	°C
ESD Rating (Human Body Model) ⁽²⁾	V_{ESD}	2	kV

Notes:

(1) Calculated from package in still air, mounted to a 3" x 4.5", 4-layer FR4 PCB with thermal vias under the exposed pad per JESD51 standards.

(2) Tested according to JEDEC standard JESD22-A114-B.

Electrical Characteristics

Unless specified, $T_A = 25^\circ\text{C}$ for Typ, -40°C to 85°C for Min and Max, $V_{IN} = 3.2\text{V}$ to 4.2V , $C_{IN} = 2.2\mu\text{F}$, $C_{OUT} = C_{PUMP} = 1\mu\text{F}$ (ESR = 0.03Ω).

Parameter	Symbol	Conditions	Min	Typ	Max	Units
Charge Pump Electrical Specifications						
Input Supply Voltage	V_{IN}		3.0		5.5	V
Maximum Total Output Current	$I_{OUT(MAX)}$	$V_{IN} > 3.4\text{V}$, sum of all active LED currents, $V_{OUT(MAX)} = 4.2\text{V}$, 500ms max.	434			mA
Individual LED Current Setting, Main Backlight	I_{Mx}	Nominal Settings	0.4		32	mA
Individual LED Current Setting, Sub/Flash	I_{SxFLy}	Nominal Settings	0.4		102	mA
Individual LED Current Accuracy	I_{LED_ACC}	$V_{IN} = 3.7\text{V}$, $I_{SET} = 0.4\text{mA}$		±30		µA
		$V_{IN} = 3.7\text{V}$, $I_{SET} = 20\text{mA}$	-8.0	±1.5	+8.0	%
		Flash pins only, $V_{IN} = 3.7\text{V}$, $I_{SET} = 102\text{mA}$		±2		%
LED Matching ⁽¹⁾	$I_{LED-LED}$	$V_{IN} = 3.7\text{V}$, $I_{SET} = 0.4\text{mA}$		±20		µA
		$V_{IN} = 3.7\text{V}$, $I_{SET} = 20\text{mA}$	-3.5	±0.5	+3.5	%
		Flash pins only, $V_{IN} = 3.7\text{V}$, $I_{SET} = 102\text{mA}$		±1		

POWER MANAGEMENT
Electrical Characteristics (Cont.)

Parameter	Symbol	Conditions	Min	Typ	Max	Units
Charge Pump Electrical Specifications (Cont.)						
1x Mode to 1.5x Mode Falling Transition Voltage	$V_{TRANS1x}$	$I_{OUT} = 70mA$ (10mA/LED), $V_{OUT} = 4V$		4.07		V
1.5x Mode to 1x Mode Hysteresis	V_{HYST1x}	$I_{OUT} = 70mA$ (10mA/LED), $V_{OUT} = 4V$		100		mV
1.5x Mode to 2x Mode Falling Transition Voltage	$V_{TRANS1.5x}$	$I_{OUT} = 70mA$ (10mA/LED), $V_{OUT} = 4V$		2.92		V
2x Mode to 1.5x Mode Hysteresis	$V_{HYST1.5x}$	$I_{OUT} = 70mA$ (10mA/LED), $V_{OUT} = 4V$		200		mV
Shutdown Current	$I_{Q(OFF)}$	$EN = GND, V_{IN} = 4.2V, T_A = 25^{\circ}C$		0.1	1.0	μA
		$EN = GND, V_{IN} = 4.2V, T_A = -40^{\circ}C$ to $+85^{\circ}C$			12 ⁽²⁾	
Total Quiescent Current	I_Q	Sleep ($EN = V_{IN}$, SLEEP = 1, no serial interface activity)		50 ⁽³⁾		μA
		1x mode, $I_{OUT} = 0.8mA$		1.00	1.85	mA
		1.5x mode, $I_{OUT} = 0.8mA, f_{PUMP} = 250kHz$		1.4		
		2x mode, $I_{OUT} = 0.8mA, f_{PUMP} = 250kHz$		1.8	3.0	
		1.5x mode, $I_{OUT} = 0.8mA, f_{PUMP} = 1.33MHz$		2.3		
		2x mode, $I_{OUT} = 0.8mA, f_{PUMP} = 1.33MHz$		3.5	5.2	
Current Sink Off-State Leakage Current	$I_{LED(OFF)}$	$V_{IN} = V_{EN} = V_{LED} = 4.2V$		0.1	1	μA
DAC Current Step Size	I_{DACSP}	8-bit register		0.4		mA
Differential Non-Linearity	DNL			± 1		LSB
Pump Frequency	f_{PUMP}	$V_{IN} = 3.2V, FSEL = 0$		250		kHz
		$V_{IN} = 3.2V, FSEL = 1$		1.33		MHz
Digital I/O Electrical Specifications (ASEL, EN, FL, MDIM, SDIM)						
Input High Threshold	V_{IH}	$V_{IN} = 5.5V$	1.6			V
Input Low Threshold	V_{IL}	$V_{IN} = 3V$			0.4	V
Input High Current	I_{IH}	$V_{IN} = 5.5V$			10	μA
Input Low Current	I_{IL}	$V_{IN} = 5.5V$			10	μA
Maximum Input Frequency (MDIM and SDIM Pins)	f_{DIM}		0		1	kHz
Maximum Input Frequency (FL Pin)	f_{FL}	50% duty cycle	0		1	kHz

POWER MANAGEMENT
Electrical Characteristics (Cont.)

Parameter	Symbol	Conditions	Min	Typ	Max	Units
I²C Interface Bus Specifications						
Digital Input Voltage	V _{B-IL}	SDA and SCL			0.4	V
	V _{B-IH}	SDA and SCL	1.6			
SDA Acknowledge Output Voltage	V _{OL}	V _{IN} = 3V, I _{B-IN(SDA)} = 3mA			0.4	V
Digital Input Current	I _{B-IN}		-0.2		0.2	μA
I/O Pin Capacitance	C _{IN}			10		pF
I²C Timing Specifications						
Clock Frequency	f _{SCL}			400	440	kHz
SCL Low Period ⁽²⁾	t _{LOW}		1.3			μs
SCL High Period ⁽²⁾	t _{HIGH}		0.6			μs
Data Hold Time ⁽²⁾	t _{HD;DAT}		0			μs
Data Setup Time ⁽²⁾	t _{SU;DAT}		100			ns
Interface Start-up Time ⁽²⁾	t _{EN}	Bus start-up time after EN is pulled high			350	μs
Setup Time for Repeated Start Condition ⁽²⁾	t _{SU;STA}		0.6			μs
Hold Time for Repeated Start Condition ⁽²⁾	t _{HD;STA}		0.6			μs
Setup Time for Stop Condition ⁽²⁾	t _{SU;STO}		0.6			μs
Bus Free Time Between STOP and START ⁽²⁾	t _{BUF}		1.3			μs
Fault Protection						
Output Short Circuit Current Limit	I _{OUT(SC)}	V _{OUT} = GND		300		mA
Over Temperature ⁽⁴⁾	T _{OTP}	Rising threshold (hysteresis = 10°C)		160		°C
Output Over Voltage	V _{OVF}			5.7		V

Notes:

(1) LED matching applies to current sinks set to the same current only. Matching is calculated as follows:

$$I_{LED-LED} = \pm \frac{(I_{MAX} - I_{MIN})}{(I_{MAX} + I_{MIN})} \cdot 100\%$$

(2) Guaranteed by design.

(3) The total quiescent current in Sleep Mode will increase when serial bus activity occurs, and with the clock frequency of that bus activity.

(4) When the junction temperature exceeds the Over Temperature (OT) threshold, the device will enter Sleep Mode with the contents of all registers retained. The device will exit Sleep Mode and re-commence normal operation as soon as the junction temperature drops by more than the OT hysteresis.

POWER MANAGEMENT

Block Diagram

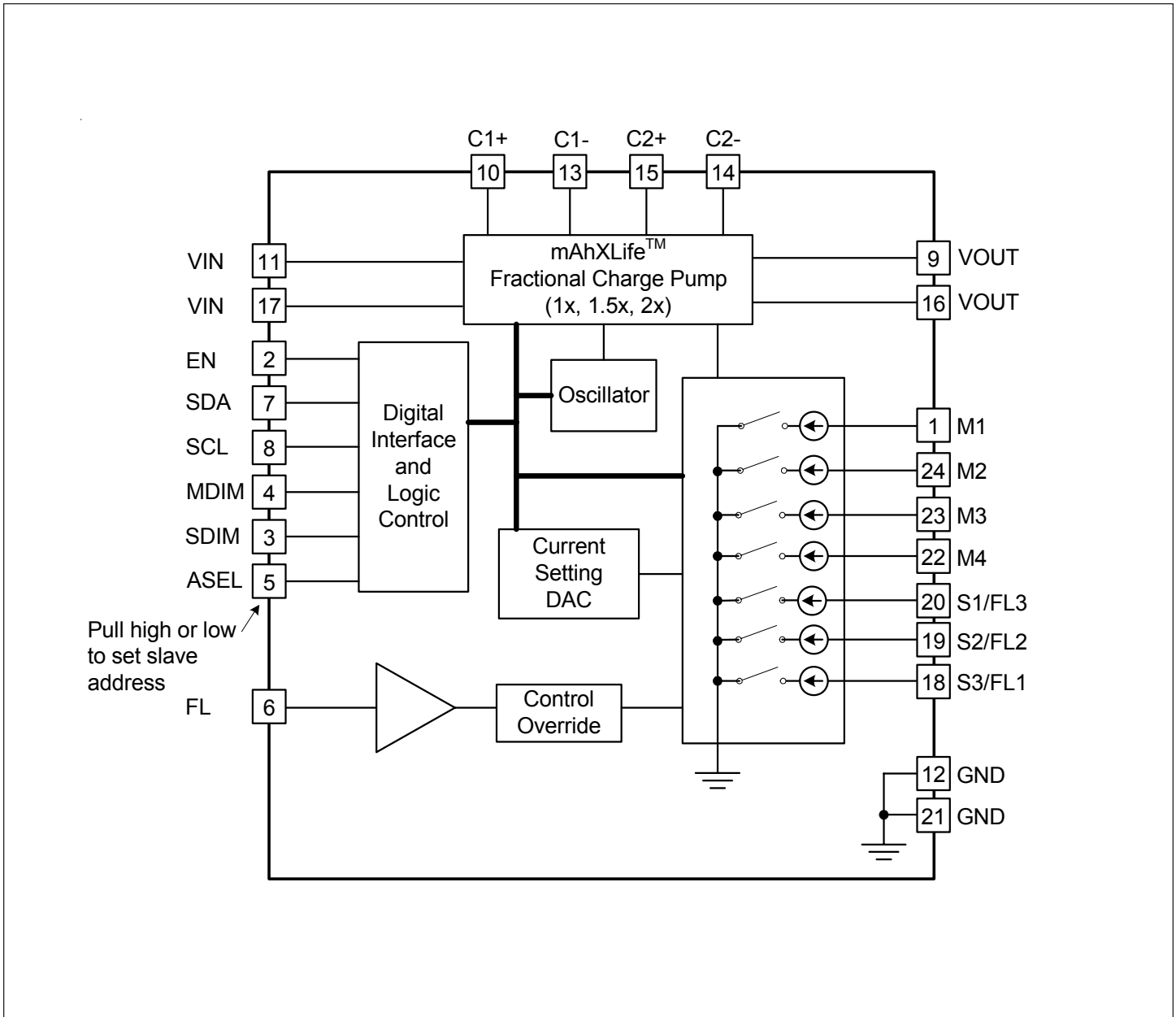

POWER MANAGEMENT

Pin Configuration

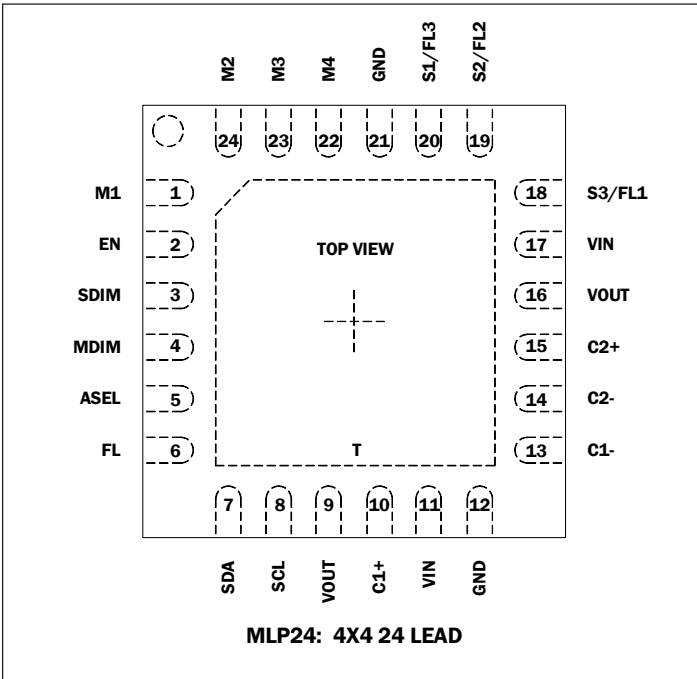

Ordering Information

Device	Package
SC614MLTRT ⁽¹⁾	MLPQ-24 ⁽²⁾
SC614DB ⁽³⁾	Demonstration Board
SC614EVB ⁽⁴⁾	Evaluation Board

Notes:

- (1) Lead free product. This product is fully WEEE and RoHS compliant.
- (2) Only available in tape and reel packaging. A reel contains 3000 devices.
- (3) The demonstration board showcases the most common uses for this part, running at maximum current settings.
- (4) The evaluation board is user-configurable and allows the user to communicate with the part using a graphical user interface on a personal computer with a USB connection. Contact factory for availability.

Marking Information

Top Mark



yy = two-digit year of manufacture
 ww = two-digit week of manufacture
 xxxxx = lot number

POWER MANAGEMENT
Pin Descriptions

Pin #	Pin Name	Pin Function
1	M1	Current sink input for main backlight LED 1. Leave unconnected if not used.
2	EN	Enable input, active high.
3	SDIM	Dimming pin for sub backlight LEDs. High = OFF, low = ON.
4	MDIM	Dimming pin for main backlight LEDs. High = OFF, low = ON.
5	ASEL	Address select. Pin can be pulled low or high to set one bit in the device address. This allows two devices to be connected to the same bus.
6	FL	Control pin for flash LEDs. High = ON, low = OFF.
7	SDA	I ² C serial data (bi-directional). An external pull-up resistor is required.
8	SCL	I ² C clock input. An external pull-up resistor is required.
9	VOUT	Charge pump output. Connect to pin 16.
10	C1+	Bucket capacitor C1 positive connection.
11	VIN	Battery voltage input. Connect to pin 17.
12	GND	Ground pin. Connect directly to ground plane.
13	C1-	Bucket capacitor C1 negative connection.
14	C2-	Bucket capacitor C2 negative connection.
15	C2+	Bucket capacitor C2 positive connection.
16	VOUT	Charge pump output. Decouple this pin using a 1 μ F ceramic capacitor to pin 21. All VOUT connections should be starred to the top of this capacitor.
17	VIN	Battery voltage input. Decouple this pin using a 2.2 μ F ceramic capacitor to pin 21.
18	S3/FL1	Current sink input for sub backlight or flash. Combine with S2/FL2 and S1/FL3 for maximum flash current capability. Leave unconnected if not used.
19	S2/FL2	Current sink input for sub backlight or flash. Combine with S1/FL3 and S3/FL1 for maximum flash current capability. Leave unconnected if not used.
20	S1/FL3	Current sink input for sub backlight or flash. Combine with S2/FL2 and S3/FL1 for maximum flash current capability. Leave unconnected if not used.
21	GND	Ground pin. Connect directly to ground plane.
22	M4	Current sink input for main backlight LED 4. Leave unconnected if not used.
23	M3	Current sink input for main backlight LED 3. Leave unconnected if not used.
24	M2	Current sink input for main backlight LED 2. Leave unconnected if not used.
-	THERMAL PAD	Pad for heatsinking purposes. Connect to ground plane using multiple vias. Not connected internally.

POWER MANAGEMENT
Register Map

Address	D7	D6	D5	D4	D3	D2	D1	D0	Reset Value	Description
0x00	0	S3/FL1EN	S2/FL2EN	S1/FL3EN	M4EN	M3EN	M2EN	M1EN	0x00	LED On/Off control
0x01	0	7-bit current setting, 0.4mA/bit, 0x00 = OFF, 0x50 = 32mA							0x00	M1 current control
0x02	0	7-bit current setting, 0.4mA/bit, 0x00 = OFF, 0x50 = 32mA							0x00	M2 current control
0x03	0	7-bit current setting, 0.4mA/bit, 0x00 = OFF, 0x50 = 32mA							0x00	M3 current control
0x04	0	7-bit current setting, 0.4mA/bit, 0x00 = OFF, 0x50 = 32mA							0x00	M4 current control
0x05	8-bit current setting, 0.4mA/bit, 0x00 = OFF, 0xFF = 102mA							0x00	S1/FL3 current control	
0x06	8-bit current setting, 0.4mA/bit, 0x00 = OFF, 0xFF = 102mA							0x00	S2/FL2 current control	
0x07	8-bit current setting, 0.4mA/bit, 0x00 = OFF, 0xFF = 102mA							0x00	S3/FL1 current control	
0x08	0	FLMODE	SLEEP	SWRES	FSEL	FL1	FL0	0	0x20	Control Register

Note: all registers are readable and writable.

Definition Of Terms:

0: Leave this bit as a 0.

xEN: On/off control for individual current sinks. Set to 1 to enable, clear to 0 to disable.

FLMODE: Flash Mode control bit. Set to 1 for Flash mode, clear to 0 for normal mode.

SLEEP: Sleep Mode control bit. Set to 1 to put into low current mode (Bandgap, UVLO monitor and interface monitoring stay on, all other circuitry shut down), clear to 0 for normal mode.

SWRES: Software Reset bit. Set to 1 to reset all registers (SWRES clears automatically and does not require an additional I²C write).

FSEL: Frequency Select bit. Allows the choice between two different switching frequencies, set to 1 for 1.33MHz, clear to 0 for 250kHz.

POWER MANAGEMENT
Register Map (Cont.)

FL1,0: Control Override bits for S1/FL3, S2/FL2 and S3/FL1. Enable control is transferred to the FL pin (assuming the LEDs are first enabled) based on the following table:

FL1	FL0	FL Pin Control Status
0	0	Control maintained by register bits - FL pin disabled.
0	1	S3/FL1 enable controlled by the FL pin.
1	0	S3/FL1, S2/FL2 enables controlled by the FL pin.
1	1	S3/FL1, S2/FL2, S1/FL3 enables controlled by the FL pin.

SC614 Slave Address

Following a start condition, the master must output the address of the slave it is accessing. The most significant six bits of the slave address are the device type identifier (ID). For the SC614 this is fixed at 111000[ASEL]. The next significant bit addresses a particular device. A system can have up to two SC614 devices on the same bus. The two addresses are defined by the state of the ASEL input (see Table below).

DEVICE TYPE IDENTIFIER						DEVICE ADDRESS	R/W
1	1	1	0	0	0	Pin ASEL to GND = 0 Pin ASEL to VIN = 1	X

POWER MANAGEMENT

State Diagrams

Start-Up

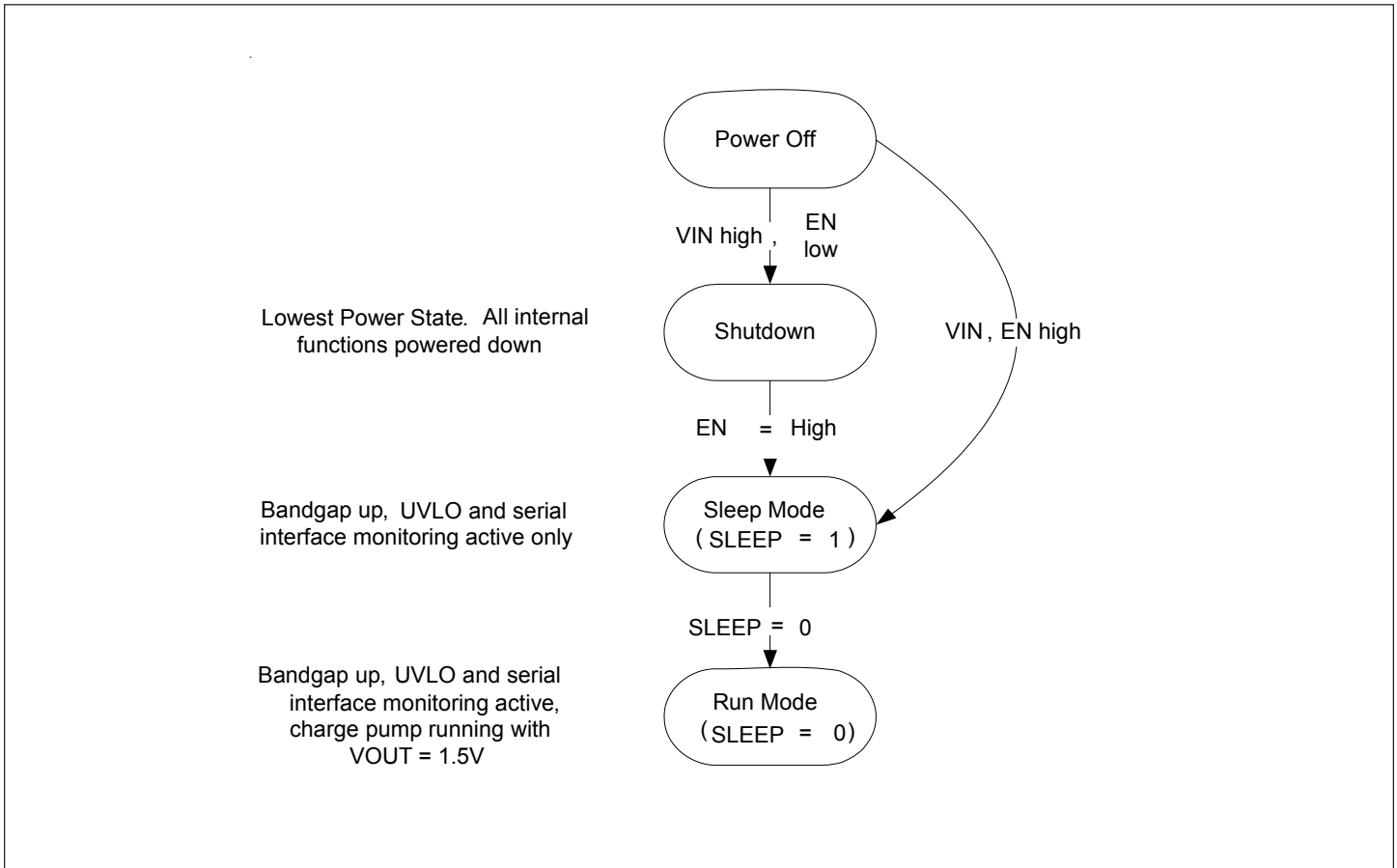

When the SC614 is first enabled, it starts up in Sleep Mode, with the registers at their reset values and the charge pump off. The bandgap reference will be operating, the input voltage will be monitored for UVLO and the serial interface will be monitored for any activity. This is the lowest power state for the device where it can be communicated with. In order to activate the charge pump it is necessary to clear the Sleep bit to 0 to enter Run Mode. When in Run Mode the charge pump is activated in 1x mode with VOUT = 1.5V, and all of the optional functions of the device may be accessed.

POWER MANAGEMENT

State Diagrams (Cont.)

Power Management

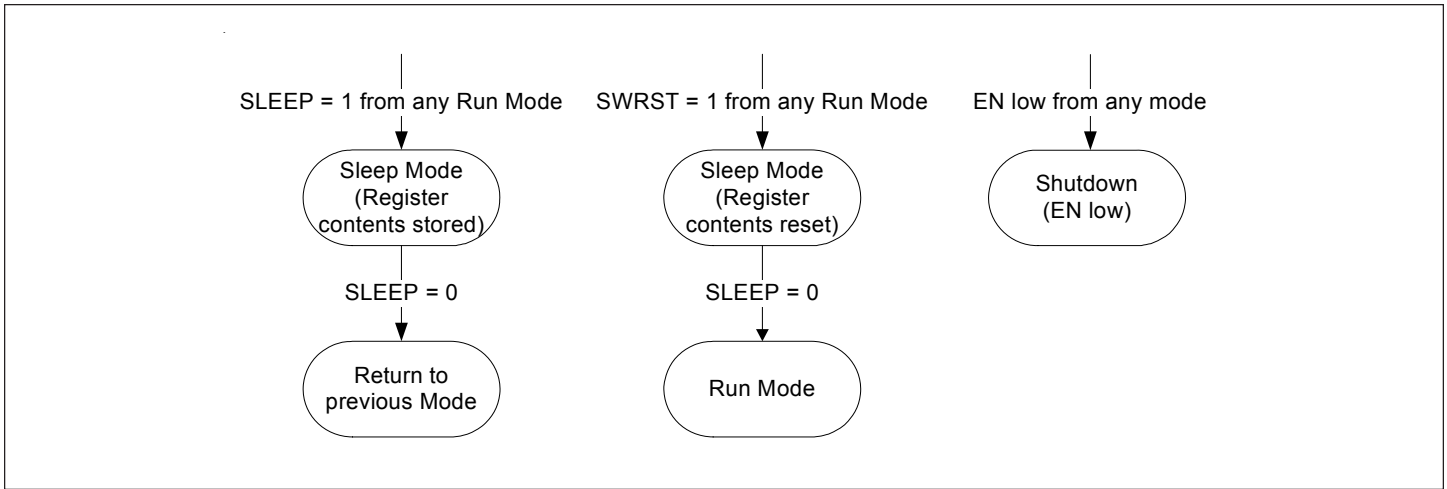

There are three options for powering down the SC614 (other than writing 0x00 to each Current Control Register or the LED On/Off Control Register):

Sleep Mode (SLEEP = 1)

Setting this bit to 1 at any time will power down the charge pump. The register contents will be stored, the bandgap reference will remain active, and UVLO and serial interface monitoring will continue. Clearing this bit will resume operation as before.

Sleep Mode from Reset (SWRES = 1)

Setting SWRES to 1 will reset all registers (clearing the SWRES bit), causing the part to enter Sleep Mode but with all registers at their reset values (0x00 for registers 0x00 through 0x07, 0x20 for Control Register 0x08 (SLEEP = 1). Upon clearing the SLEEP bit, the SC614 will enter run mode and will require writing to the registers to commence driving LEDs.

Shutdown (EN low)

All internal functions are powered down. Pulling EN high will enter Sleep Mode with all registers reset.

Device Operation With All LEDs Disabled

If the SC614 is driving LEDs and then all LEDs are disabled, the device reverts to 1x mode with a nominal output voltage of 3V. This decreases the response time when the LEDs are enabled once more. Quiescent current in this mode will be 700µA (nom).

POWER MANAGEMENT
Applications Information
General Operation

The SC614 contains a fractional charge pump, mode selection circuitry, serial I/O logic, serial data registers and current regulation circuitry for 7 LED outputs. All are depicted in the Block Diagram on page 5.

The fractional charge pump multiplies the input voltage by 1, 1.5 or 2 times the input voltage. The charge pump switches at a fixed frequency that is bit selectable to 1.33MHz or 250kHz. The default frequency is 250kHz. The charge pump does not switch during 1x mode, saving power and improving efficiency.

The mode selection circuitry automatically selects the mode as 1x, 1.5x or 2x based on circuit conditions such as LED voltage, input voltage and load current. 1x is the most efficient mode, followed by 1.5x and 2x modes. At lower input voltages a stronger mode may be needed to maintain regulation. If so, the mode will change first to 1.5x and then later to 2x. 2x mode usually operates for a much shorter run time compared to 1x mode, and 2x mode maintains the output until the battery is discharged to 3V or less. The LED requiring the highest voltage drop will determine the output voltage needed to drive all outputs with sufficient anode voltage. Comparing all cathodes and regulating V_{OUT} for the LED with the lowest cathode voltage ensures sufficient bias for all LEDs.

The LED outputs are controlled through the serial data registers, found in the Register Map on page 8. LED on/off functions are independently controlled, so that any combination of LEDs may be switched on.

Seven (7) current regulating circuits sink currents from the LEDs as set by the Current Control registers. For LCD backlighting applications current matching is crucial, and LEDs with matched forward voltage will produce the best possible matched currents. The SC614 is capable of dealing with V_F mis-matches up to 0.5V. For best matching performance, however, it is recommended that the LED to LED difference, ΔV_F, be under 250mV.

Designing for Lowest Possible Battery Current

The battery current and efficiency of the SC614 are mostly dependent on the charge pump mode of operation. To get the best performance from the SC614 it is better to use LEDs with consistently lower V_F. Lower V_F will keep the charge pump in 1x mode longer and will use less battery current, extending the run time of the battery.

Mode Transition Threshold Voltage and Hysteresis

Mode transition threshold voltage refers to the input voltage at the point when the charge pump changes from a weaker mode (lower numerically) to a stronger mode (higher numerically). V_{TRANS1X} is the transition from 1x to 1.5x mode, and V_{TRANS1.5X} is the transition from 1.5x to 2x mode.

Mode transition voltages V_{TRANS1X} and V_{TRANS1.5X} can be estimated by the following equations:

$$V_{\text{TRANS1X}} = V_F + V_{\text{ILED}} + I_{\text{OUT}} \cdot 1.0$$

$$V_{\text{TRANS1.5X}} = (V_F + V_{\text{ILED}} + I_{\text{OUT}} \cdot 5.5) / 1.5$$

where V_F is the highest forward voltage of the operating LEDs, V_{ILED} is the current sink voltage for that LED (typically V_{ILED}=150mV) and I_{OUT} is the sum of all operating LED currents.

The mode transition circuitry has hysteresis built in to prevent the device from toggling between modes when the input voltage is right at the threshold of mode change. There is 100mV of hysteresis between 1.5x and 1x modes and 200mV of hysteresis between 2x and 1.5x modes.

Efficiency

Power efficiency can be estimated for any particular battery voltage as follows:

$$\eta = [V_{\text{OUT}} \cdot I_{\text{OUT}} / V_{\text{IN}} \cdot (I_{\text{OUT}} \cdot \text{Mode} + I_Q)] \cdot 100 \%$$

where:

$$V_{\text{OUT}} = V_F + V_{\text{ILED}} \text{ (defined in the above section).}$$

and,

$$I_Q = 1\text{mA in } 1\text{x mode, } 1.4\text{mA in } 1.5\text{x mode and } 1.8\text{mA in } 2\text{x mode (250kHz).}$$

LED Current Accuracy

The LED current is set by the Current Control registers 0x01 through 0x07. The guaranteed accuracy of any current sink is +/-8% at a current setting of 20mA, with the typical accuracy much higher at +/-1.5%. For example, if the Current Control registers are configured such that each LED current will be 20mA (0x32 written to register 0x01 through 0x07), the actual LED currents

POWER MANAGEMENT
Applications Information (Cont.)

would be between 18.4mA and 21.6mA (+/-8%). All 7 outputs meet this requirement over the industrial temperature range. To calculate the accuracy based upon the actual measured LED current, I_{LED_ACC} , use the following formula:

$$I_{LED_ACC} = \pm \frac{(I_{LED(Measured)} - I_{LED(SET)})}{I_{LED(SET)}} \cdot 100\%$$

Current Matching

The current matching percentage is a figure that represents how closely matched LEDs are that are set to the same current. For any particular LED within a group of LEDs set to the same current, the matching is the ΔI for that LED from the average of the minimum and maximum value of the group (i.e. the center of the measured current range) expressed as a percentage of that average.

Current matching is calculated as follows:

$$I_{LED_LED} = \left(\frac{I_{MAX}}{\left(\frac{I_{MAX} + I_{MIN}}{2} \right)} \right) \cdot 100\% \quad \text{or} \quad \left(\frac{I_{MIN}}{\left(\frac{I_{MAX} + I_{MIN}}{2} \right)} \right) \cdot 100\%$$

Which can be reduced to:

$$I_{LED_LED} = \pm \frac{(I_{MAX} - I_{MIN})}{(I_{MAX} + I_{MIN})} \cdot 100\%$$

Protection Circuitry

The SC614 also provides protection circuitry that prevents the device from operating in an unspecified state. These include Output Over-Voltage Protection (OVP), Over-Temperature Protection (OTP), Over-Current Protection (OCP) and Short-Circuit Protection (SCP).

Output Over-Voltage Protection

Output over-voltage protection is included to prevent the SC614 from generating an output voltage that could damage other devices connected to it such as load LEDs any bypass capacitors. When the output voltage exceeds 5.7V, the OVP circuitry disables the charge pump until the output voltage decreases to an acceptable level. Usually the only reason for the output voltage to trip OVP is if one of the LEDs goes open. If this happens the SC614 will raise the output voltage to attempt to bring

that LED current back into regulation. When the OVP trip point is reached, the charge pump will be turned off. Any current sinks that measure close to ground will be turned off in an attempt to isolate the faulty LED. Once the output voltage drops enough the charge pump will resume operation.

Over-Temperature Protection

The over-temperature protection circuitry helps to prevent the device from overheating and experiencing a catastrophic failure. When the junction temperature exceeds 160°C the output is disabled and the device enters sleep mode. All register settings are retained. The junction temperature must drop by more than the hysteresis of 10°C before the part exits sleep mode and re-commences normal operation.

Over-Current and Short Circuit Protection

Adaptive current limit circuitry is provided to protect the device from various levels of shorts from resistive to full shorts as well as to limit in-rush current at start-up and during mode transitions. The current limit levels adjust to the total output current set for the LEDs and thus will be higher when very high levels of currents are programmed, such as for flash operation. The current limit levels are set to ensure that the device will not current limit under normal operation. When an output short circuit occurs, the device folds back the current limit level to a nominal 300mA. If sustained current limit occurs the device may shut down due to internal heating triggering the OTP circuitry.

Capacitor Selection

The SC614 is designed to use low-ESR ceramic capacitors for all four external capacitors: input, output and charge pump bucket capacitors. Ideal performance is achieved when the bucket capacitors (C3 and C4 in the application circuit) are exactly equal. *Note: It is recommended that X5R or X7R capacitors are used for best performance.*

Thermal Resistance and Heat Management

The SC614 is packaged in a thermally efficient MLPQ24 package that has a thermal pad to remove the heat from the part. It is intended to be connected using multiple vias to the ground plane, and the thermal resistance rating of 40°C/W reflects this. A good layout will enable the part to operate at maximum output current ratings without tripping the OTP circuitry.

POWER MANAGEMENT

Applications Information (Cont.)

Layout Guidelines

The following layout is suggested (shown as three-layer (top, bottom and ground layer) only for clarity). C1 is the input capacitor which should be placed close to pin 17. C2 is the output capacitor which should be placed close to pin 16. The capacitors C3 and C4 are the bucket capacitors which can carry up to the full load current of 434mA pulsed for one half clock cycle (at either 250kHz or 1.33MHz depending upon selected operating frequency). Multiple vias should be used whenever it is necessary to change layers on nets connecting to CIN, VOUT, C1+, C1-, C2+ and C2-. As mentioned before, the thermal pad should connect to ground using multiple vias, with 4 vias recommended.

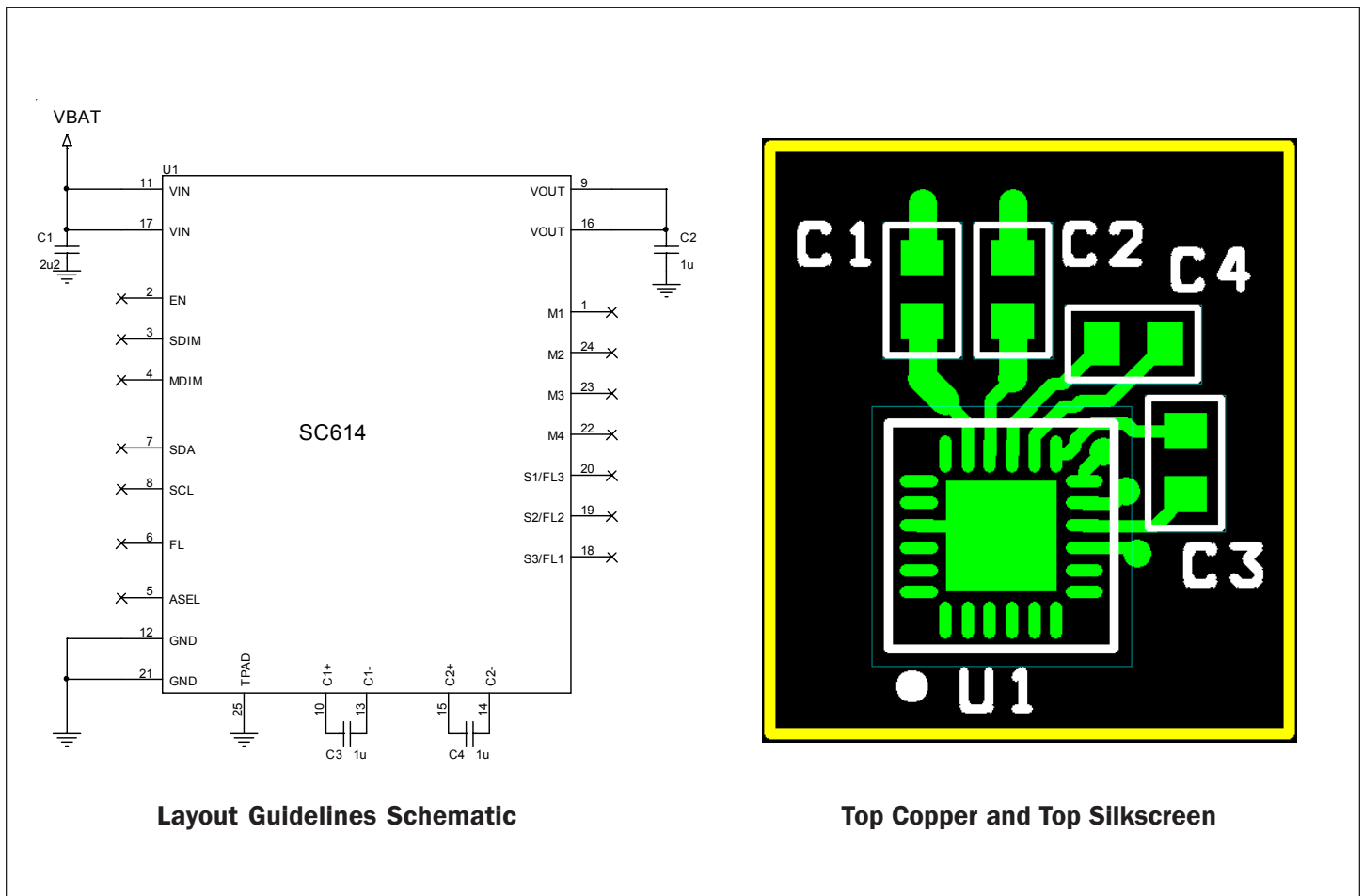

POWER MANAGEMENT

Applications Information (Cont.)

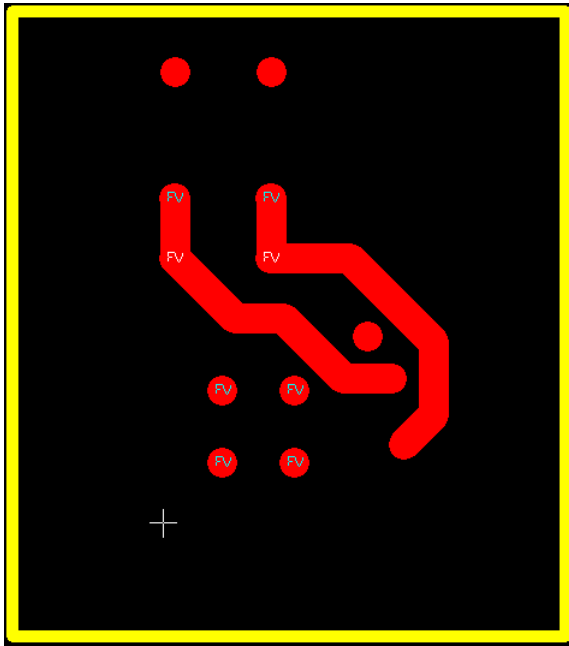

Bottom Copper

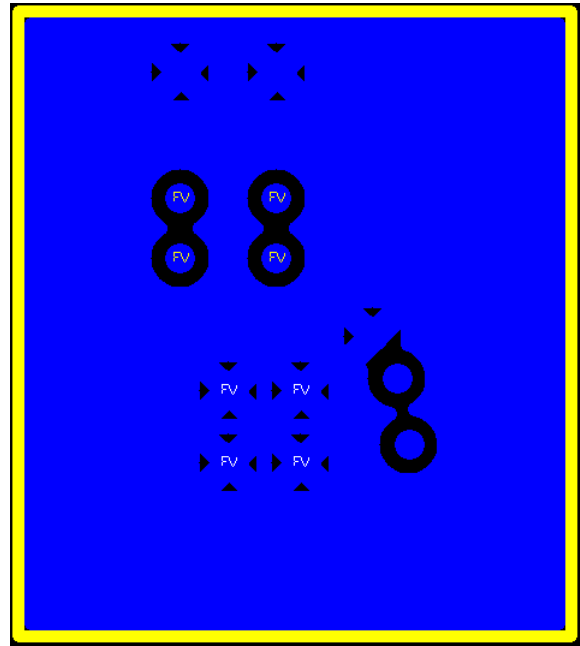

Ground Layer

POWER MANAGEMENT

Application Examples

Main Backlight Plus Flash

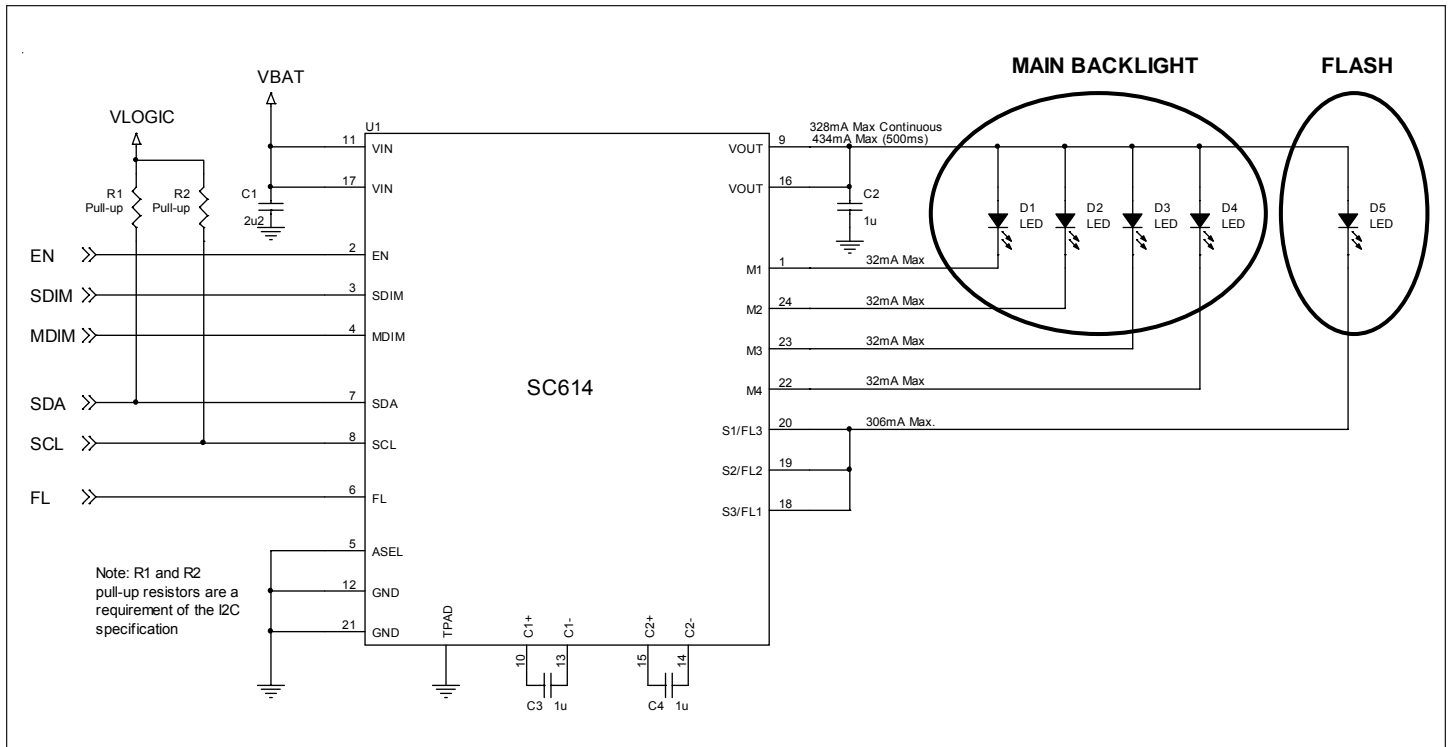

Features:

- Up to 4 LED main backlight with up to 32mA per LED
- PWM dimming of backlight using MDIM pin
- Up to 306mA flash capability controlled by FL pin

Register Settings (20mA backlight currents and 300mA flash current used as an example):

0x00: set to 0x7F to enable all 7 current sinks for use
 0x01 through 0x04: set to 0x32 for 20mA per current sink
 0x05 through 0x07: set to 0xFA for 100mA per current sink, 300mA total
 0x08: set to 0x46 for Flash Mode enabled, 250kHz charge pump frequency, FL pin controls S1/FL3, S2/FL2 and S3/FL1

POWER MANAGEMENT

Application Examples (Cont.)

Main Backlight Plus Sub-Backlight

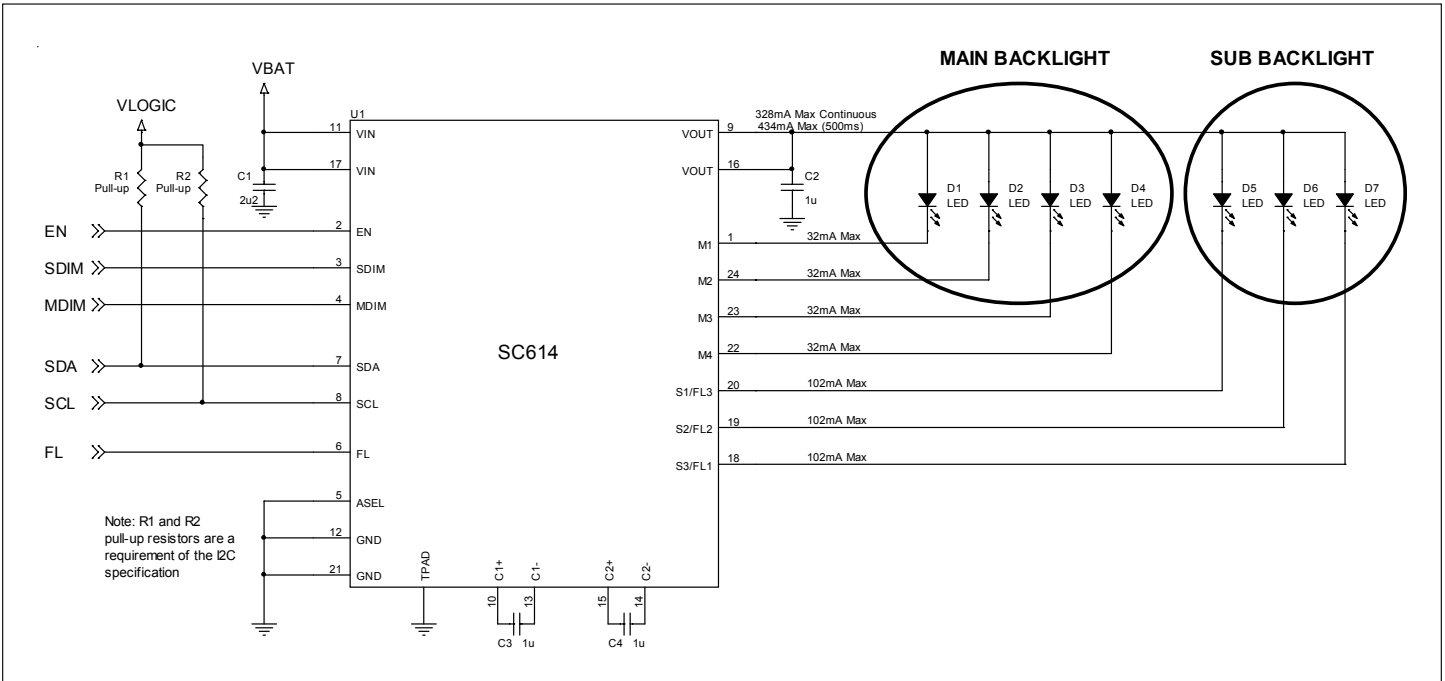

Features:

- Up to 4 LED main backlight with up to 32mA per LED
- PWM dimming of main backlight using MDIM pin
- Up to 3 LED sub-backlight with up to 32mA per LED
- PWM dimming of sub-backlight using SDIM pin

Register Settings (20mA backlight currents used as an example):

0x00: set to 0x7F to enable all 7 current sinks for use (or as needed if less)

0x01 through 0x07: set to 0x32 for 20mA per current sink

0x08: set to 0x00 for Flash Mode disabled (FL pin inactive) and 250kHz charge pump frequency

POWER MANAGEMENT

Application Examples (Cont.)

Main Backlight Plus Sub-Backlight Plus Flash

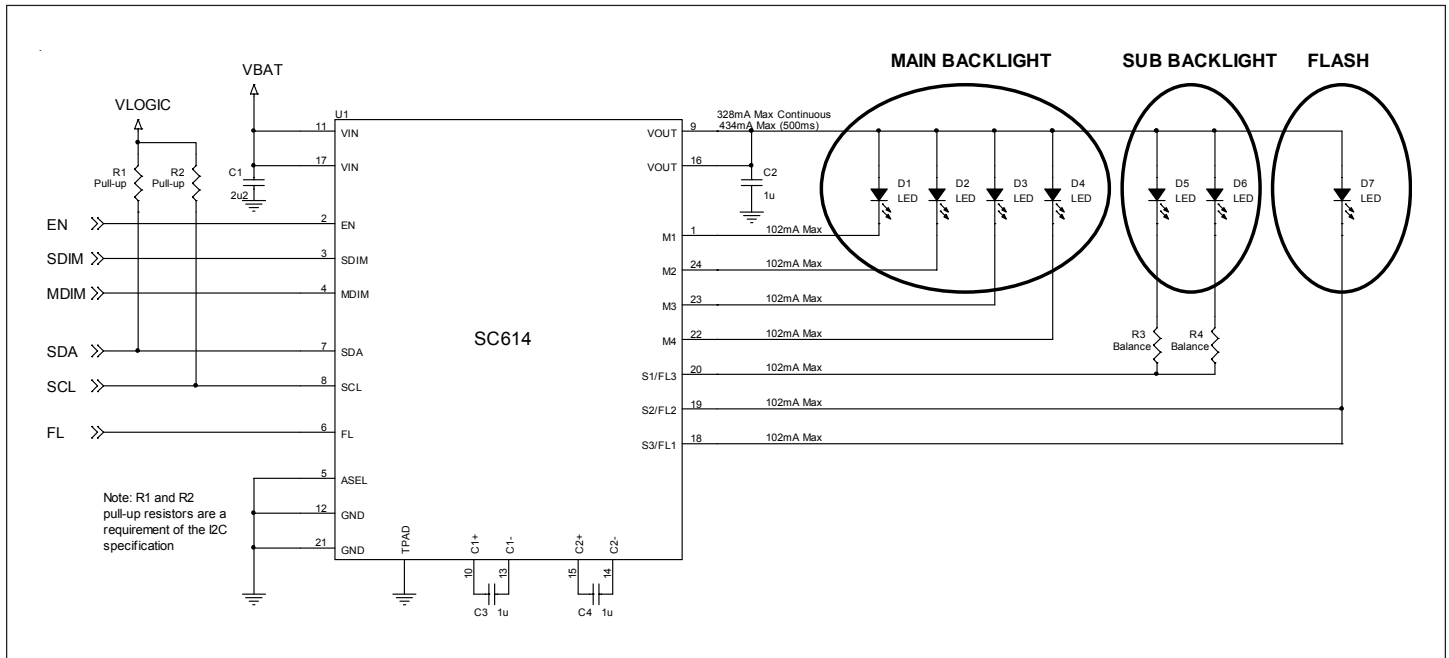

Features:

- Up to 4 LED main backlight with up to 32mA per LED
- PWM dimming of main backlight using MDIM pin
- Up to 2 LED sub-backlight with up to 32mA per LED using resistor current balancing
- PWM dimming of sub-backlight using SDIM pin
- Up to 204mA flash capability controlled by FL pin

Register Settings (20mA backlight currents and 200mA flash current used as an example):

- 0x00: set to 0x7F to enable all 7 current sinks for use
- 0x01 through 0x04: set to 0x32 for 20mA per current sink
- 0x05: set to 0x64 for 40mA for this current sink (20mA per LED)
- 0x06 and 0x07: set to 0xFA for 100mA per current sink, 200mA total
- 0x08: set to 0x44 for Flash Mode enabled, 250kHz charge pump frequency, FL pin controls S2/FL2 and S3/FL1

POWER MANAGEMENT

Application Examples (Cont.)

Main Backlight Plus RGB Indicator

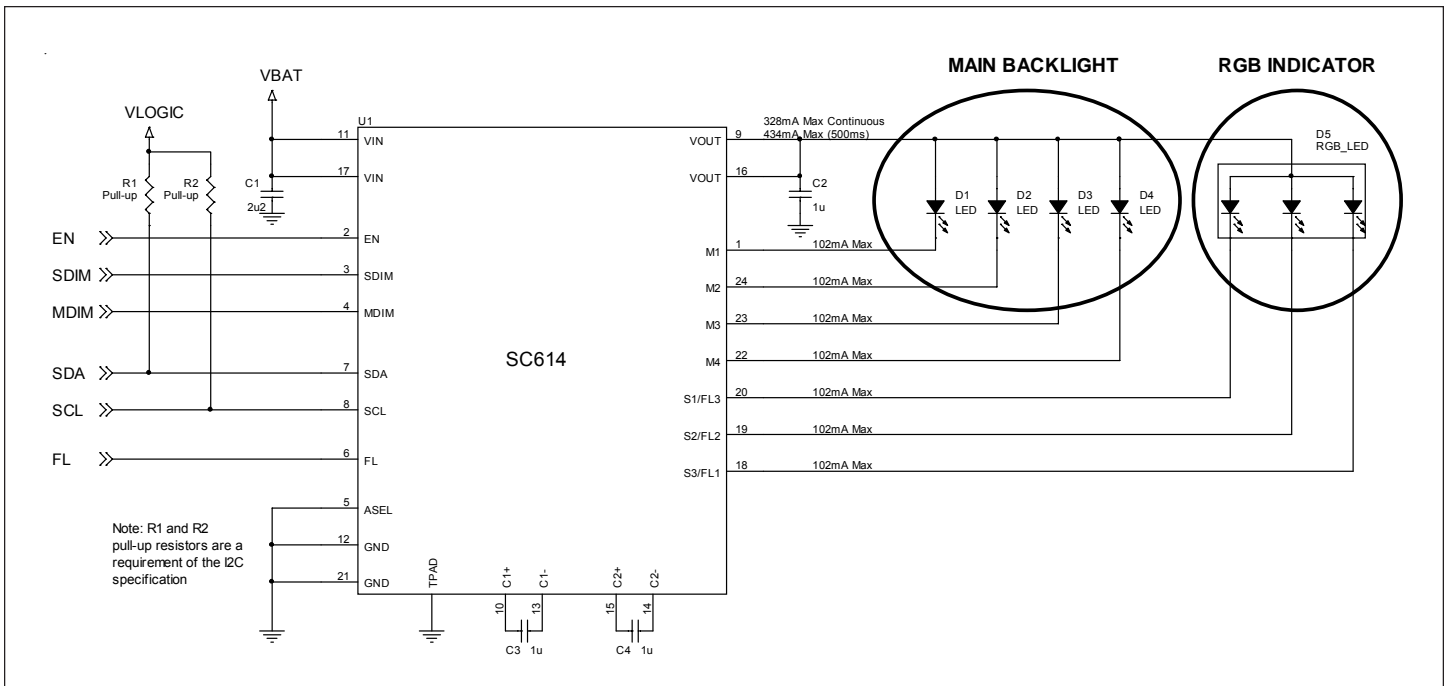

Features:

- Up to 4 LED main backlight with up to 32mA per LED
- PWM dimming of backlight using MDIM pin
- 3 current sinks for RGB with up to 32mA per LED
- Dimming and color rotation of RGB over I²C interface

Register Settings (20mA backlight currents and as required on the fly RGB current used as an example):

- 0x00: set to 0x7F to enable all 7 current sinks for use
- 0x01 through 0x04: set to 0x32 for 20mA per current sink
- 0x05 through 0x07: set to as required on the fly for each color
- 0x08: set to 0x00 for Flash Mode disabled (FL pin inactive) and 250kHz charge pump frequency

POWER MANAGEMENT
Using the I²C Serial Port
The I²C General Specification

The SC614 is a read-write slave-mode I²C device and complies with the Philips I²C standard Version 2.1 dated January 2000. The SC614 has nine user-accessible internal 8-bit registers. The I²C interface has been designed for program flexibility, in that once the slave address has been sent to the SC614 enabling it to be a slave transmitter/receiver any register can be written or, read from independently of each other. While there is no auto increment/decrement capability in the SC614 I²C logic, a tight software loop can be designed to randomly access the next register independent of which register you begin accessing. The start and stop commands frame the data-packet and the repeat start condition is allowed if necessary.

SC614 Limitations to the I²C specifications

Seven bit addressing is used and ten bit addressing is not allowed. Any general call address will be ignored by the SC614. The SC614 is not CBUS compatible. Finally, the SC614 can operate in standard mode (100kbit/s) or fast mode (400kbit/s).

Supported Formats

Direct Format - Write: The simplest format for an I²C write is the direct format write. After the master sends a start condition, the slave address is sent followed by an eighth bit indicating a write. The SC614 then acknowledges that it is being addressed, and the master responds with an 8-bit data byte consisting of the target register address. The slave acknowledges and the master sends the appropriate 8-bit data byte. Once again the slave acknowledges and the master terminates the transfer with a stop condition.



S:	Start Condition	Slave Address:	7 bit
W:	Write = 0	Register Address:	8 bit
A:	Acknowledge (SDA low)	Data:	8 bit
P:	Stop Condition		

Shaded represents transmission from master to slave and unshaded represents transmission from slave to master.

Combined Format (Read/Write): After a start condition, the slave address is sent followed by an eighth bit indicating a write. The SC614 then acknowledges that it is being addressed, and the master responds with an 8 bit data byte consisting of the target register address. The slave acknowledges once more and the master sends the repeated start condition. Once again, the slave address is sent, followed by an eighth bit indicating a read or write. The slave responds with an acknowledge. If the command was a write, the master sends the appropriate 8-bit data byte. Once again the slave acknowledges and the master terminates the transfer with a stop condition. If the command was a read, the slave sends the appropriate 8-bit data byte, to which the master sends a not acknowledge and then terminates the transfer with a stop condition.



S:	Start Condition	N:	Not Acknowledge (SDA high) ⁽¹⁾
W:	Write = 0	P:	Stop Condition
A:	Acknowledge (SDA low)	Slave Address:	7 bit
Sr:	Repeated Start Condition	Register Address:	8 bit
R:	Read = 1	Data:	8 bit

Shaded represents transmission from master to slave and unshaded represents transmission from slave to master.

(1) Not shaded because transfer direction depends upon R/W bit.

POWER MANAGEMENT

Using the I²C Serial Port (Cont.)

Stop Separated Reads: A further form of read is available which is, in effect, an extension of the combined format read. This format allows a master to set up the register address pointer for a read, and return to that slave some time later to read the data. After a start condition, the slave address is sent, followed by a write. The SC614 then acknowledges that it is being addressed, and the master responds with the 8-bit target register address. The master then sends a stop or repeated start condition, and may address another slave. Some time later the master sends a start or repeated start condition, and a valid slave address is sent, followed by a read. The SC614 then acknowledges and returns the data at the register address location that had previously been set up.

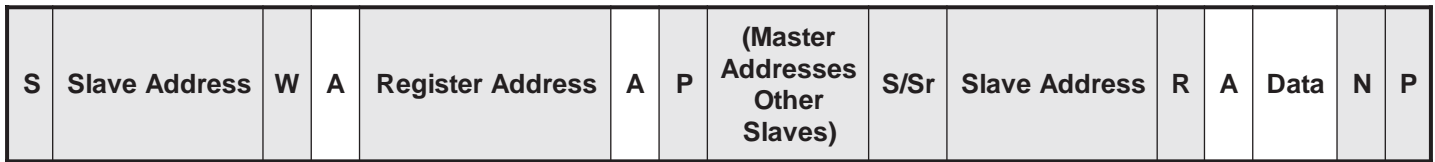

- S: Start Condition
 - W: Write = 0
 - A: Acknowledge (SDA low)
 - P: Stop Condition
 - Sr: Repeated Start
 - R: Read = 0
- Slave Address: 7 bit
 - Register Address: 8 bit
 - Data: 8 bit

Shaded represents transmission from master to slave and unshaded represents transmission from slave to master.

POWER MANAGEMENT

Typical Characteristics

Battery Current (Sub-only)

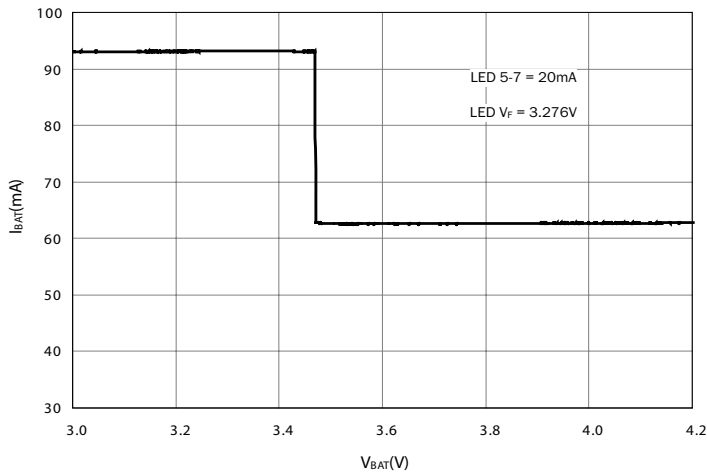

Battery Current (Main and Sub)

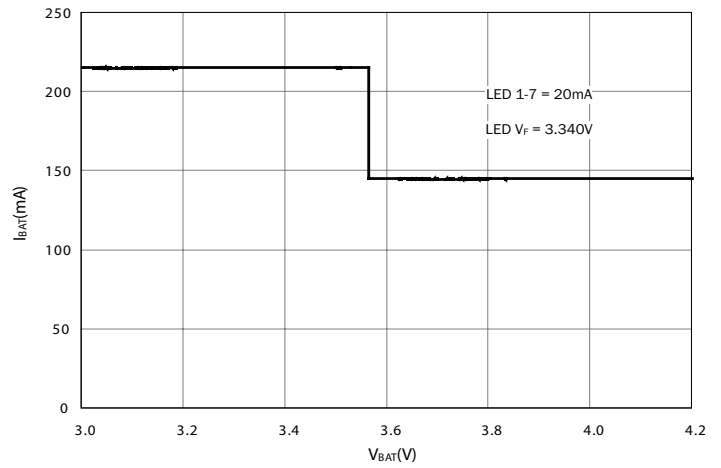

Power Efficiency (Sub-only)

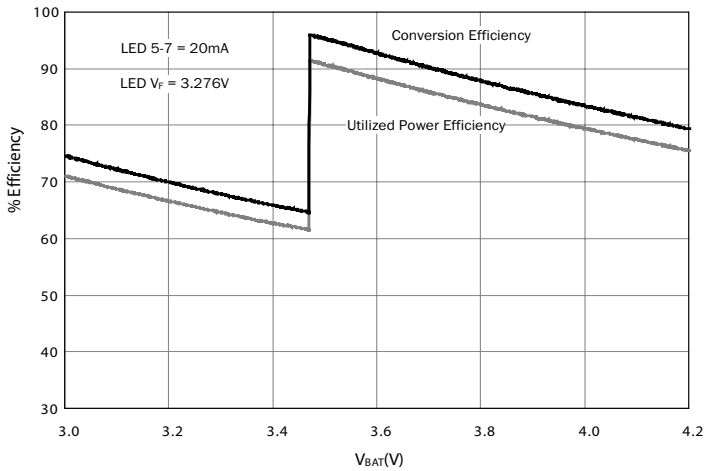

Power Efficiency (Main and Sub)

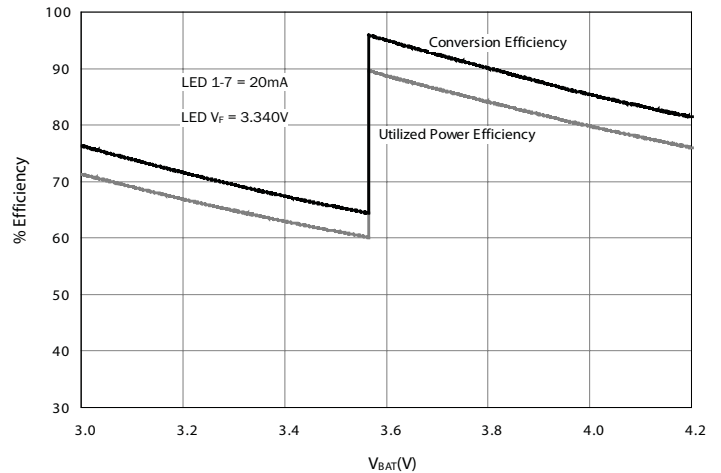

Typical LED Matching (Main and Sub)

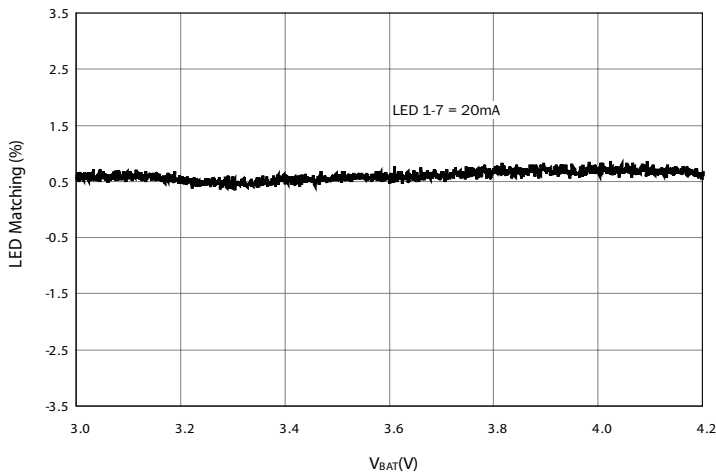

Typical LED Accuracy (Main and Sub)

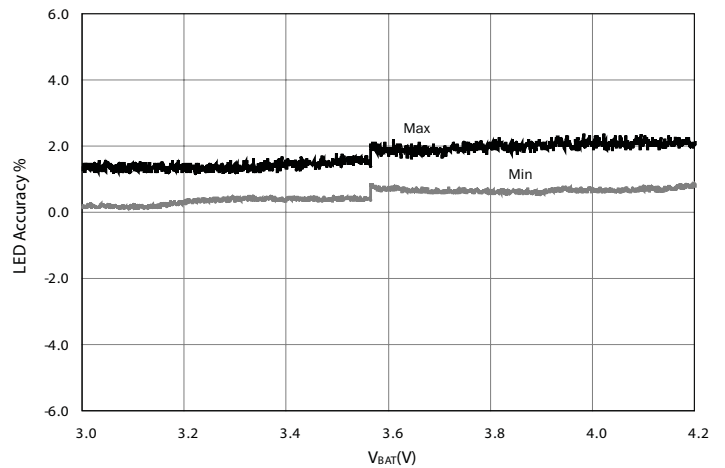

POWER MANAGEMENT

Typical Characteristics (Cont.)

Battery Current (Main and Flash)

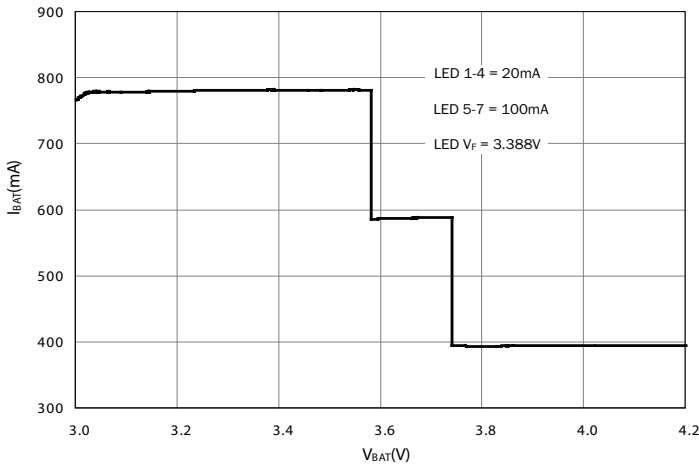

Battery Current (Main only)

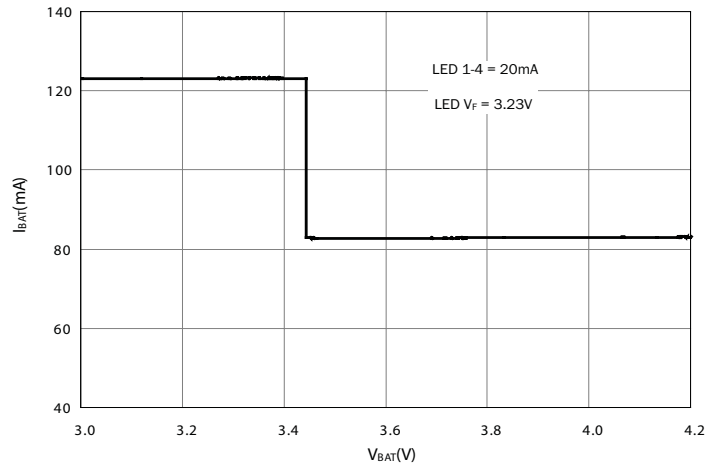

Power Efficiency (Main and Flash)

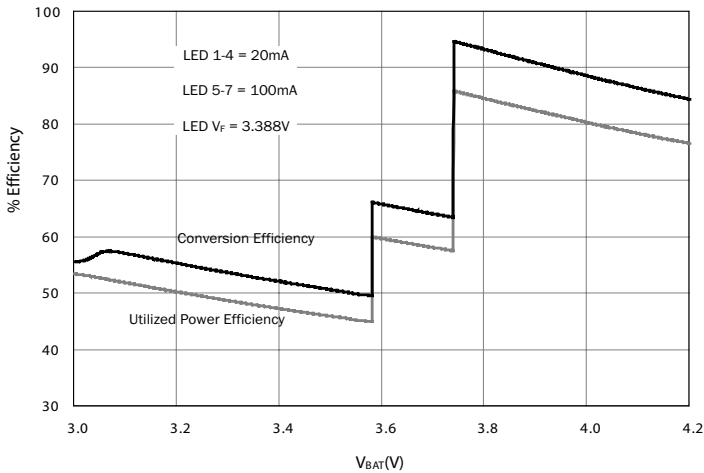

Power Efficiency (Main only)

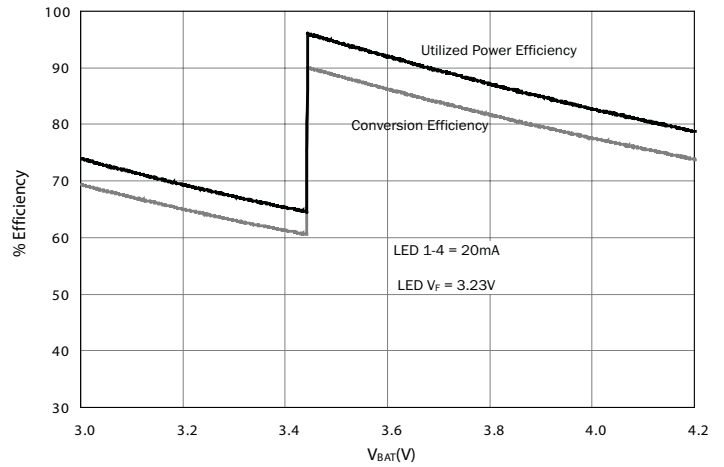

POWER MANAGEMENT

Outline Drawing MLPQ-24 4 x 4

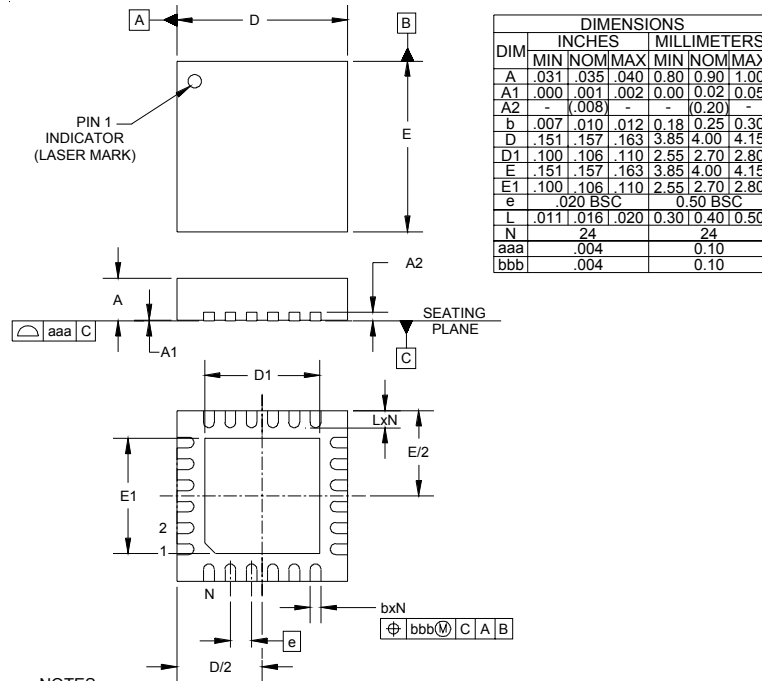

NOTES:

1. CONTROLLING DIMENSIONS ARE IN MILLIMETERS (ANGLES IN DEGREES).
2. COPLANARITY APPLIES TO THE EXPOSED PAD AS WELL AS THE TERMINALS.

POWER MANAGEMENT

Land Pattern MLPQ-24 4 x 4

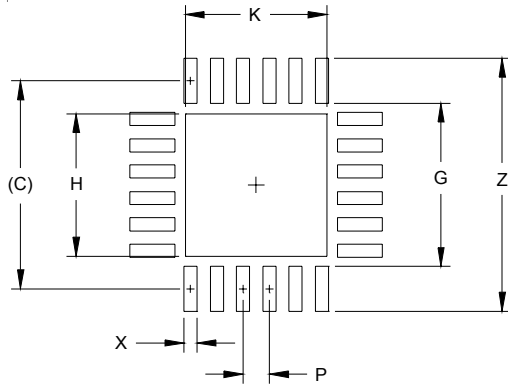

DIMENSIONS		
DIM	INCHES	MILLIMETERS
C	(.155)	(3.95)
G	.122	3.10
H	.106	2.70
K	.106	2.70
P	.021	0.50
X	.010	0.25
Y	.033	0.85
Z	.189	4.80

NOTES:

1. THIS LAND PATTERN IS FOR REFERENCE PURPOSES ONLY. CONSULT YOUR MANUFACTURING GROUP TO ENSURE YOUR COMPANY'S MANUFACTURING GUIDELINES ARE MET.

Contact Information

Semtech Corporation
 Power Management Products Division
 200 Flynn Road, Camarillo, CA 93012
 Phone: (805) 498-2111 FAX (805)498-3804

Visit us at: www.semtech.com