

---

# Planar F-Antenna Reference Design

## AN1200.20

---

TCo

## Table of Contents

<b>1</b>	<b>General Description .....</b>	<b>3</b>
<b>2</b>	<b>Specifications .....</b>	<b>3</b>
<b>4</b>	<b>Layout Considerations .....</b>	<b>4</b>
<b>3</b>	<b>Simulated Gain Performance .....</b>	<b>6</b>
<b>4</b>	<b>Feedpoint Measurements (868 MHz Tuning).....</b>	<b>8</b>
<b>5</b>	<b>Feedpoint Measurements (915 MHz Tuning).....</b>	<b>8</b>
<b>6</b>	<b>Proximity Detection Range .....</b>	<b>9</b>
<b>7</b>	<b>Influence of the Proximity sensor on Antenna Tuning .....</b>	<b>9</b>

## Table of Figures

Figure 1. The Antenna on a Reference Design PCB.....	3
Figure 2. Implementation Details of the Antenna.....	4
Figure 3. Full PCB Dimensions, Including Ground Area.....	5
Figure 4. Simulated 2D Radiation Pattern .....	6
Figure 5. Simulated 3D Radiation Pattern of the Antenna.....	7
Figure 6. Measured 868 MHz  S11  .....	8
Figure 7. Measured 915 MHz  S11  .....	8
Figure 8. Measured SAR Coverage with 868 MHz Current Density.....	9
Figure 9. Measured Input  S11  both with and without SAR Patch.....	9

## 1 General Description

This application note describes a Planar-F antenna which also features an optional patch element that can be used for detection of a proximate object by capacitive proximity detection. This element, in conjunction with a Semtech SX9500, allows the detection of a proximate hand or finger in the antenna near-field. This enables RF power control to both exploit the maximum regulatory output power and SAR limits and protect power amplifiers from antenna detuning.

Designed for use on a low-cost 1.6 mm FR-4 substrate this design is intended to provide close to 0 dBi omnidirectional gain and to be sufficiently close to 50 ohms that, in cost constrained applications; no impedance matching components are required.

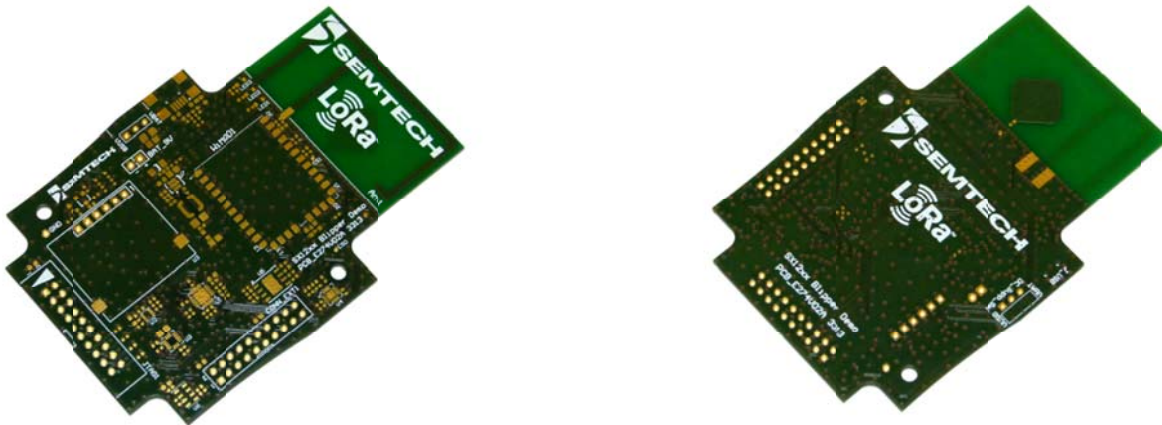

Figure 1. The Antenna on a Reference Design PCB

## 2 Specifications

Specifications and simulated performances are listed for the 868 MHz implementation unless otherwise stated. Note that performances are dependent upon use of identical PCB dimensions and substrate electrical characteristics.

Parameter	Typical Performance	Units
Peak Gain	-0.6	dBi
Average Gain	-2.8	dBi
Return Loss (863 to 870 MHz)	>10	dB

## 4 Layout Considerations

The antenna performance is subject to layout on a PCB of identical dimensions to those of the reference design. The antenna must be configured as illustrated below. The tuning length required for each band is as follows:

**5 mm = 868 MHz band**  
**2 mm = 915 MHz band**

Note that the proximity sensor patch is located on bottom layer and the antenna is on top layer. The proximity patch features a narrow (0.2 mm wide) groove to avoid unwanted coupling in the wanted frequency bands.

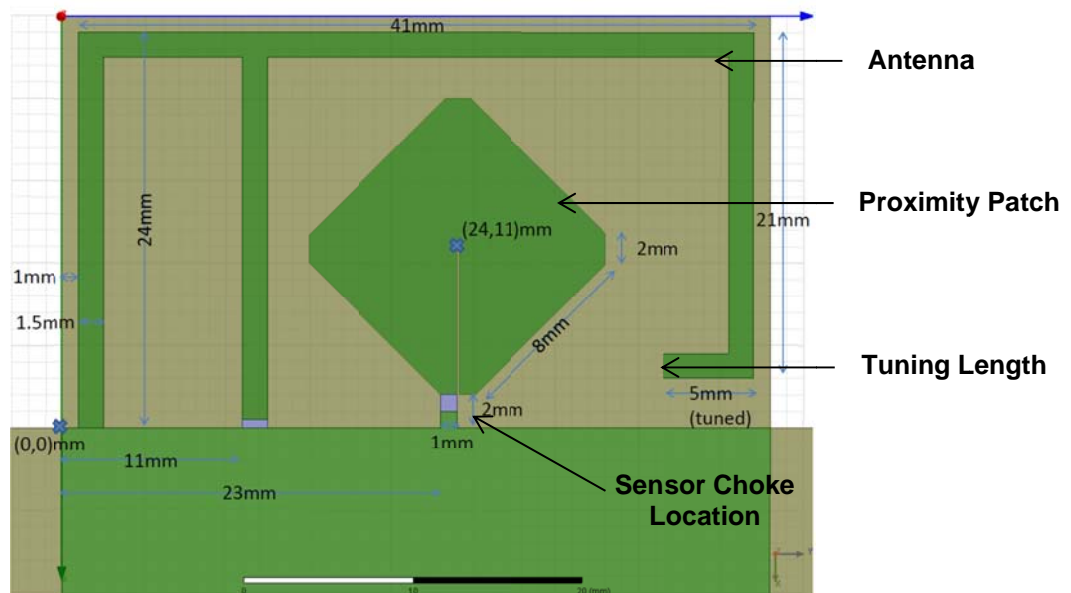

**Figure 2. Implementation Details of the Antenna.**

It is important to note that the size of the ground area can also influence the overall performance of the antenna. The whole ground area is available for population with design components. However, it is recommended that a continuous ground plane be implemented with ground vias stitching the edges of the PCB together.

To allow replication of the ground / design surface area the full dimensions of the PCB are shown in the image overleaf.

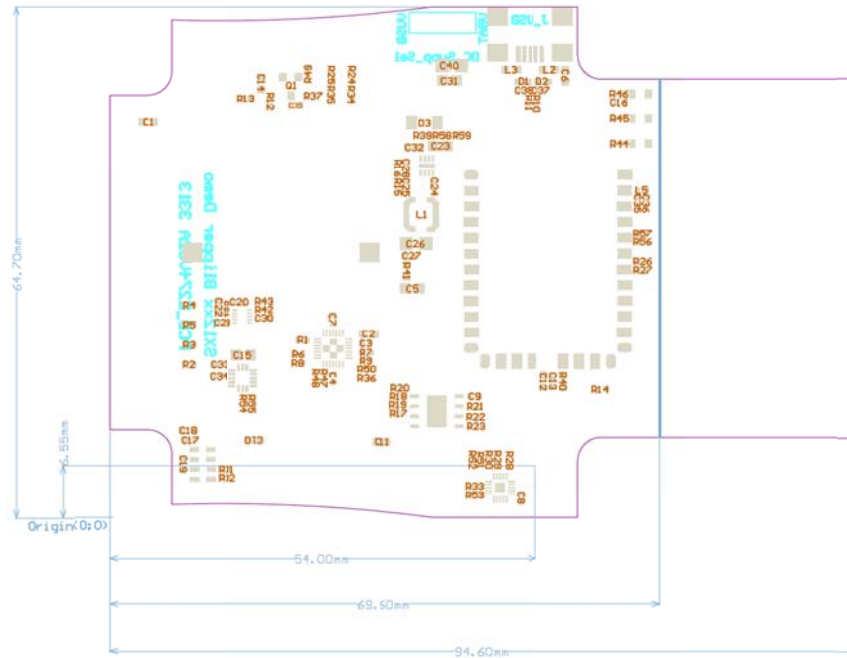
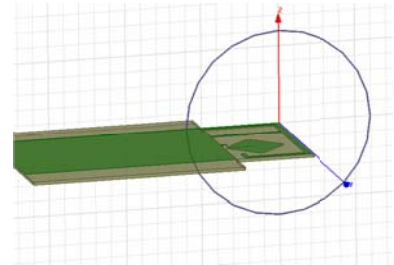
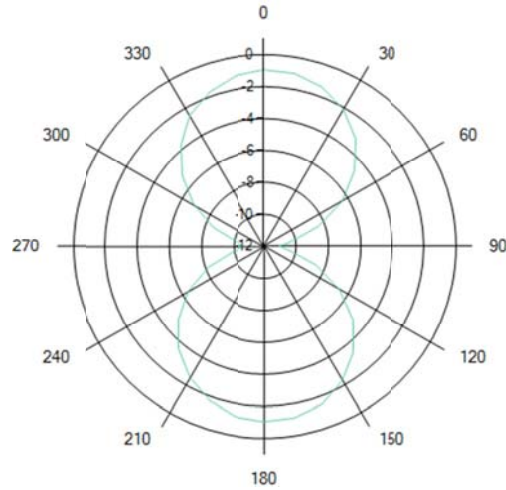
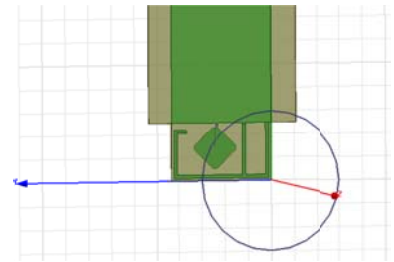
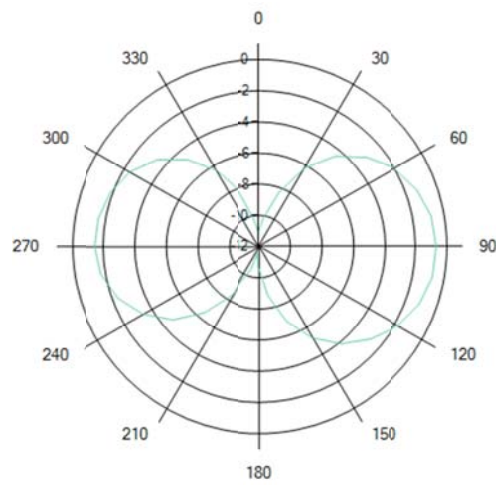

Figure 3. Full PCB Dimensions, Including Ground Area.

### 3 Simulated Gain Performance



**Total Gain [dBi]  
X-Z Plane**



**Total Gain [dBi]  
X-Y Plane**

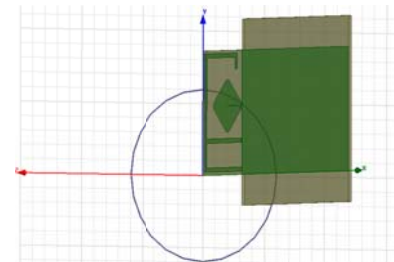
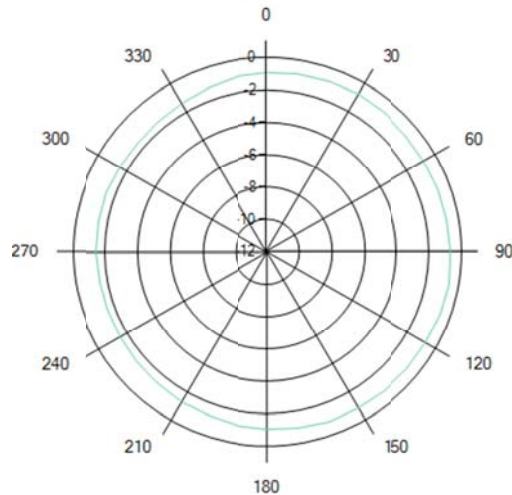

**Total Gain [dBi]  
Y-Z Plane**

**Figure 4. Simulated 2D Radiation Pattern**

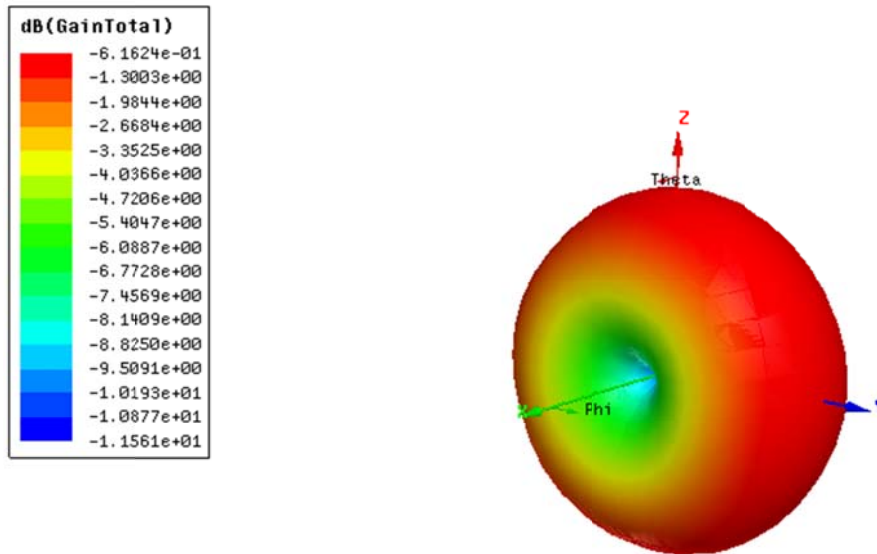

**Figure 5. Simulated 3D Radiation Pattern of the Antenna.**

The simulated omnidirectional gain performance of the antenna is shown above. The inset images show the orientation of the PCB antenna relative to the radiation pattern.

## 4 Feedpoint Measurements (868 MHz Tuning)

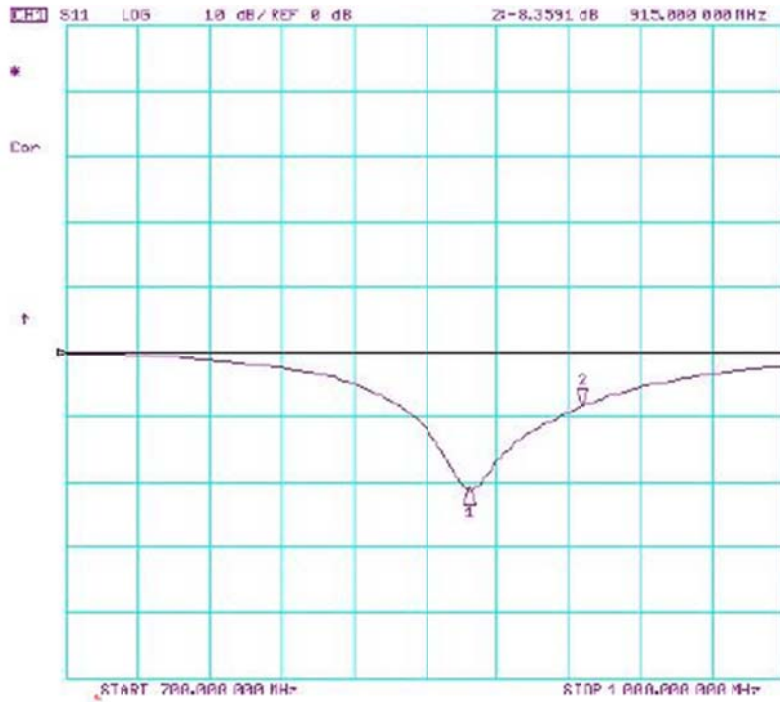

Figure 6. Measured 868 MHz |S11|

CH1 Markers  
1:-21.031 dB  
968.000 MHz

Antenna measurement was performed in final evaluation kit packaging.

No matching components are required.  
Sensor Choke = 180 nH.



## 5 Feedpoint Measurements (915 MHz Tuning)

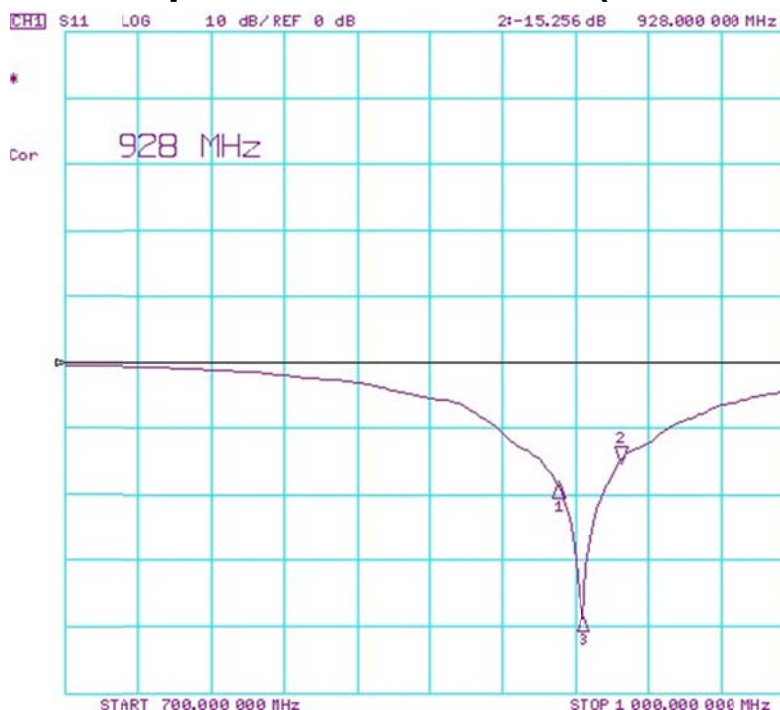

Figure 7. Measured 915 MHz |S11|

CH1 Markers  
1:-18.150 dB  
902.000 MHz  
3:-38.330 dB  
912.390 MHz



## 6 Proximity Detection Range

The image below is a representation of the measured proximity detection range of the sensor element in conjunction with the SX9500 capacitive proximity detector. Coverage extends to 15 mm beyond both sides of the surface of the antenna structure. Coverage is coincident with the areas of highest surface current density of the antenna structure.

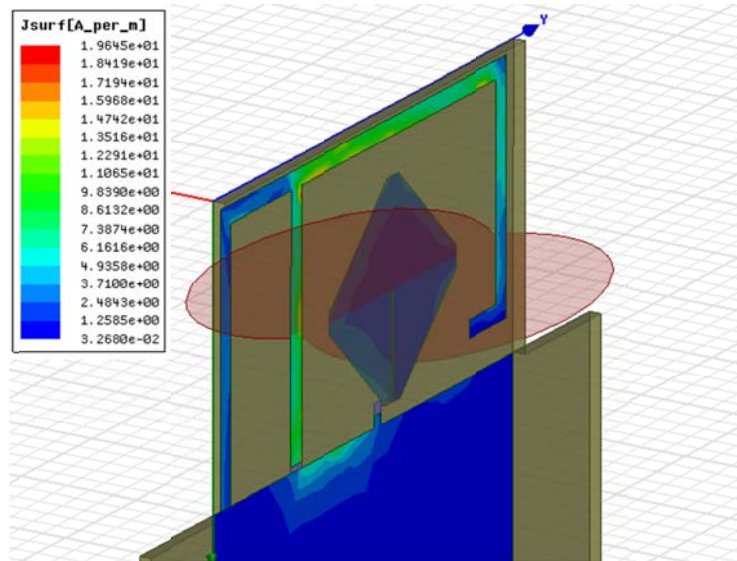

Figure 8. Measured SAR Coverage with 868 MHz Current Density

## 7 Influence of the Proximity sensor on Antenna Tuning

The antenna can also be used without the proximity sensor patch. As shown below, the measured resonant frequency is not dependent upon the presence of the patch - only the depth of the resonance.

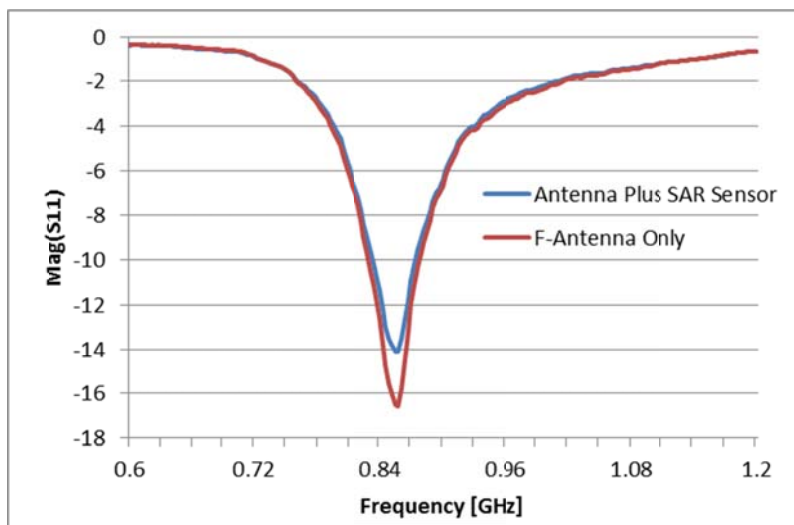

Figure 9. Measured Input |S11| both with and without SAR Patch.

© Semtech 2014

All rights reserved. Reproduction in whole or in part is prohibited without the prior written consent of the copyright owner. The information presented in this document does not form part of any quotation or contract, is believed to be accurate and reliable and may be changed without notice. No liability will be accepted by the publisher for any consequence of its use. Publication thereof does not convey nor imply any license under patent or other industrial or intellectual property rights. Semtech assumes no responsibility or liability whatsoever for any failure or unexpected operation resulting from misuse, neglect improper installation, repair or improper handling or unusual physical or electrical stress including, but not limited to, exposure to parameters beyond the specified maximum ratings or operation outside the specified range.

SEMTECH PRODUCTS ARE NOT DESIGNED, INTENDED, AUTHORIZED OR WARRANTED TO BE SUITABLE FOR USE IN LIFE-SUPPORT APPLICATIONS, DEVICES OR SYSTEMS OR OTHER CRITICAL APPLICATIONS. INCLUSION OF SEMTECH PRODUCTS IN SUCH APPLICATIONS IS UNDERSTOOD TO BE UNDERTAKEN SOLELY AT THE CUSTOMER'S OWN RISK. Should a customer purchase or use Semtech products for any such unauthorized application, the customer shall indemnify and hold Semtech and its officers, employees, subsidiaries, affiliates, and distributors harmless against all claims, costs damages and attorney fees which could arise.

#### Contact Information

**Semtech Corporation**  
**Wireless, Sensing & Timing Products Division**  
**200 Flynn Road, Camarillo, CA 93012**  
**Phone: (805) 498-2111 Fax: (805) 498-3804**  
**E-mail: [sales@semtech.com](mailto:sales@semtech.com)**  
**[support\\_rf@semtech.com](mailto:support_rf@semtech.com)**  
**Internet: <http://www.semtech.com>**